

# **MK15**

## **MINI HANDHELD GROUND STATION USER MANUAL**



**V1.4**

**Sep 2023**

Thank you for purchasing SIYI product.

**MK15 Enterprise Edition** is a mini handheld ground station with a communication distance of up to 15 kilometers, which is based on SIYI Technology's fully independently developed low-latency wireless high-definition image transmission technology and is deeply integrated and optimized with Qualcomm's eight-core CPU chip platform. It has rich functions and powerful performance, and can also be purchased with dual operator, remote control relay and other features. Its abundant interfaces and strong scalability can be widely used in fields such as drones, unmanned vehicles and ships, and intelligent robots.

**MK15 Agriculture Edition** is a smart remote controller with screen, equipped with low-latency wireless high-definition image transmission technology and Qualcomm eight-core CPU chip platform. The communication distance is deeply optimized for low-altitude scenes unique to agriculture operations. MK15 carries a 1080p high-definition bright display, which is powerful, stable, and reliable. It is compatible with the A2 mini ultra-wide-angle FPV gimbal or the IP67 waterproof camera exclusive for agriculture drones and is suitable for popular drone frames and flight controllers in the market. MK15 leads the trend and is a wise choice for agriculture operations.

To ensure you a good experience of the product, please read this manual carefully.

If you encounter any issue using the product, please consult the manual or check

the online pages of this product on SIYI official store (<https://shop.siyi.biz>). You can also write an email to SIYI official A/S center ([support@siyi.biz](mailto:support@siyi.biz)).

### SIYI User Group - Facebook



**SIYI Official Store** (<https://shop.siyi.biz>)

**SIYI Official AliExpress Store** (<https://siyi.aliexpress.com>)

**SIYI YouTube Channel** (<https://www.youtube.com/c/SIYITech>)

## User Manual Update Log

Version	Date	Updates
1.4	2023.9	<ol style="list-style-type: none"> <li>1. Necessary update for product introduction.</li> <li>2. Necessary update for SIYI FPV app.</li> <li>3. User manual update log.</li> <li>4. Main firmware update log.</li> <li>5. SIYI FPV app update log.</li> <li>6. Necessary update for technical specification.</li> <li>7. Necessary update for packing list.</li> <li>8. Necessary update for “Important Instructions on Promotion to Communication Range and Video Fluency”.</li> <li>9. Necessary update for “SIYI TX App”.</li> <li>10. Instruction in “Datalink” for connection to multiple GCS.</li> </ol>

**CONTENT**

READ TIPS .....1

    Icons.....1

    Safety.....1

    Battery .....3

    Storage / Carrying / Recycling .....4

1 INTRODUCTION .....5

    1.1 Product Features.....5

    1.2 Parts .....8

        1.2.1 At a Glance .....8

        1.2.2 Button / Switch Types and Default Channel Definitions .....10

        1.2.3 Ports and Data Stream.....11

    1.3 Technical Specification.....14

    1.4 Packing List.....19

    1.5 Status Indicator Definition .....22

        1.5.1 Transmitter Indicator.....22

        1.5.2 Air Unit Indicator.....23

2 GET READY TO USE .....25

    2.1 Remote Controller .....25

        2.1.1 Power On / Off.....25

        2.1.2 Charging .....26

        2.1.3 Charging Indicator.....26

        2.1.4 Change System Language .....27

    2.2 Important Instructions on Promotion to Communication Range and Video Fluency .....31

        2.2.1 General Precautions.....31

        2.2.2 General Antenna Options and Wireless Mode Configuration for Different Range .....32

        2.2.3 How to Place the Standard Omni Antennas on Ground Unit.....33

        2.2.4 How to Place the Long-Range Patch Antennas on Ground Unit.....34

        2.2.5 How to Place Air Unit Antennas.....34

        2.2.6 The Communication Range Is Not as Expected and You Need Factory Support, Here Are the Necessary Information We Need.....38

3 SIYI TX APP .....40

3.1 Channels.....	40
3.1.1 End Point.....	41
3.1.2 Middle Point.....	42
3.1.3 Channel Reverse.....	42
3.1.4 Channel Mapping.....	43
3.2 Datalink.....	44
3.2.1 Connection.....	44
3.2.2 Flight Controller.....	45
3.2.3 Baud Rate.....	46
3.3 System.....	48
3.3.1 Bind.....	49
3.3.2 Multiple Air Unit.....	49
3.3.3 Frequency Self-Adapting.....	50
3.3.4 Throttle Stick.....	51
3.3.5 Channel 15.....	51
3.3.5 Wireless Mode.....	51
3.3.7 Joystick Deadzone.....	52
3.4 Link Status.....	53
3.5 Failsafe.....	54
3.6 Buttons / Dials.....	57
3.6.1 Buttons.....	57
3.6.2 Dials.....	58
3.7 Joystick Calibration.....	59
3.8 Dial Calibration.....	62
3.9 Multiple Links.....	65
3.9.1 Remote Control Relay.....	66
3.9.2 Dual Operator.....	67
3.10 Device Info.....	70
3.11 SIYI TX App Update Log.....	71
4 DATALINK.....	72
4.1 Communication with Android GCS through UART.....	72
4.2 Communication with Android GCS through USB COM.....	76

4.3 Communication with Android GCS via Bluetooth.....	79
4.4 Communication with Android GCS through UDP.....	83
4.5 Communication with Windows GCS through Upgrade Port.....	87
4.6 Communication with Windows GCS by UDP through Remote Controller WiFi Hotspot.....	91
4.7 Solutions to Disconnection.....	95
4.8 SIYI Datalink SDK.....	97
5 SIYI FPV APP.....	104
5.1 Settings.....	106
5.2 Link Status.....	107
5.3 Gimbal Camera.....	108
5.4 About SIYI FPV.....	110
5.5 SIYI FPV App Update Log.....	111
6 IMAGE TRANSMISSION.....	112
6.1 Control Gimbal Camera from SIYI FPV App or SIYI QGC App on SIYI Handheld Ground Station.....	112
6.1.1 Preparation.....	112
6.1.2 Gimbal Pitch and Yaw Rotation.....	114
6.1.3 Zoom.....	115
6.1.4 Take pictures and Record Video.....	115
6.2 Input Third-Party IP Cameras / Optical Pods.....	115
6.3 Input HDMI Camera.....	116
6.4 Input Dual-Channel Video Streams.....	117
6.4.1 Input Dual SIYI Cameras / Gimbals / Air Unit HDMI Input Converters.....	117
6.4.2 Input Dual Third-Party IP Cameras / Optical Pods.....	117
6.4.3 Input an SIYI HDMI Converter and a Third-Party IP Camera.....	118
6.5 Common IP Addresses.....	119
6.6 Solutions to No Image.....	120
6.7 Output Video Stream from Remote Controller.....	122
6.7.1 Through HDMI.....	122
6.7.2 Through WiFi Hotspot.....	122
7 ANDROID OS.....	124
7.1 Download Apps.....	124
7.2 Import and Install App.....	124

---

7.2.1 Through TF Card.....	124
7.2.2 Through USB Disk.....	124
7.2.3 Through Type-C File Transfer.....	125
7.3 Check Android Firmware Version.....	128
8 SIYI Assistant.....	129
8.1 Firmware Update.....	130
8.2 Main Firmware Update Log.....	133
8.3 SIYI Assistant Update Log.....	134
9 After-sale Service.....	135
9.1 Repair Service.....	135
9.2 Warranty.....	136
9.2.1 7-Day Return & Refund.....	136
9.2.2 15-Day Replacement.....	137
9.2.3 1-Year Warranty Repair.....	139
10 FCC STATEMENT.....	141





## READ TIPS

### Icons

Please pay more attention to content indicated with the following marks:

 **DANGER** Dangerous manipulation probably leads to personal injuries.

 **WARNING** Warnings on manipulation possibly leads to personal injuries.









 **CAUTION** Cautions on what manipulation may lead to economic losses.

 **Prohibited**    **Mandatory**    **Mark**

### Safety

MK15 mini handheld ground station is designed and manufactured for professional application scenarios. Operators need to have certain basic skills, so please use it with caution. SIYI Technology does not assume any responsibility for any unnecessary product damage caused by irregular or irresponsible operation of this product, economic losses or even personal injury to the user or others. Minors must have professionals present to supervise and guide minors when using this product. SIYI Technology's products are designed for commercial use, and it is prohibited to use SIYI products for military purposes. It is prohibited to disassemble or modify this product without SIYI Technology's permission.

To jointly maintain flight safety and allow you to better utilize the features of this product, please pay special attention to the following matters:

-  It is prohibited to operate in crowded places (squares, parks, etc.), places with many obstacles (streets, parking lots, etc.), places with strong magnetic fields or signal interference sources (high-voltage lines, railway lines, radar stations, etc.) or other places that may cause using SIYI products to control aircraft, vehicles or models in areas where unnecessary economic losses or even personal injuries will occur.
-  During operation, never cover the remote controller antenna or otherwise block signal transmission.
-  The top of the standard omni-directional antenna on the remote controller is the part where signal transmission is weakest. Avoid pointing it at your aircraft, vehicle or model while working.
-  It is prohibited to use SIYI products to control aircraft, vehicles, or models when you are tired, drunk, or unwell.
-  Without special operation permission, it is prohibited to use SIYI products to control aircraft, vehicles, or models in rainy days, at night or in strong wind environments.
-  When the engine or motor on your aircraft, vehicle or model is still running, do not cut off the power to the remote controller in advance.
-  For flight safety, please keep the aircraft within sight when operating the aircraft.
-  When working, be sure to return to the main page from the system parameter setting page.

- ❗ Before starting the operation, be sure to check the power of the remote controller and the power supply voltage of the air unit.
- ❗ When finishing the operation, first power off the air unit and then the remote controller.
- ❗ Before setting the remote controller parameters, be sure to power off the engine and motor to prevent accidental start.
- ❗ Before starting the operation, be sure to pre-set the fail-safe function on the remote control or in the ground station software.
- ❗ When installing, please avoid installing the air unit and GPS module too close to avoid interference. It is recommended that the distance between the air unit and the GPS module be longer than 20 cm.

## Battery

MK15 remote controller is equipped with a built-in and chargeable Li-on battery. Please do read the precautions below before using.

- ⊘ The remote controller cannot be charged when it is powered on. Before charging the remote control, please turn off the remote control.
- ⊘ If you find that the battery is smoking, overheating, or bulging, please stop using it immediately.
- ⊘ If you find smoke or a strange smell coming from the remote controller, please stop using it immediately and contact your reseller or SIYI after-sales service center directly.
- ⊘ If the remote controller overheats (above 60 degrees Celsius), please stop using it immediately and cut off the power supply.

## **Storage / Carrying / Recycling**

When the SIYI product you own is idle, or you want to take the SIYI product out for work, or the product has reached the end of its service life, please pay special attention to the following matters:



### **DANGER**

When SIYI products are not in use, they should be kept away from areas easily accessible to children.

Please avoid placing SIYI products in an environment that is too hot (above 60 degrees Celsius) or too cold (below minus 20 degrees Celsius).



### **CAUTION**

Please avoid placing SIYI products in humid or sandy environments.

When carrying and transporting SIYI products, please avoid operations that may damage components such as vibration or impact.

# 1 INTRODUCTION

## 1.1 Product Features

### 15 KM Wireless Digital Image Transmission

#### Dual-Channel Full HD Video Stream

The link of MK15 is based on SIYI's independent wireless HD image transmission technology, which is an all-in-one link integrated with remote control, datalink, and video streaming. The technology has a smart feature that the transmission can automatically adapt to the frequency band with least interference.

*\*MK15 enterprise edition with standard omni antennas, the transmission range is up to 15 kilometers.*

*\*MK15 enterprise edition with directional antennas, the transmission range is up to 30 kilometers.*

*\*To experience the lowest latency, it is suggested to use MK15 with SIYI FPV app (choosing SIYI camera protocol) or SIYI QGC app (integrated SIYI camera protocol).*

### 5.5-Inch High-Definition Monitor

#### 1000-Nit High Brightness Display

MK15 remote controller comes with a built-in 7-inch high-definition and high brightness monitor. Max 1000 nit (cd/m<sup>2</sup>) of brightness presents high clear screen display information from ground control software and high-quality images.

### Android OS, Superior Performance

MK15 remote controller carries Qualcomm 8-core CPU, which can smoothly decode 1080p 60 fps video stream by hardware in either H264 or H265 format and can efficiently run various ground control software.

*\*MK15 Android platform also comes with full band 4G network and supports streaming HD video to cloud server by SDK development.*

## **Dual Operator, Efficient Collaboration**

Targeting popular industry application fields, relying on wireless high-definition image transmission technology, SIYI has given the MK15 link the feature of dual operator.

The "dual operator" function is developed for dual-operator scenarios and supports up to two ground units to establish links with the same air unit at the same time. One can be used to control the flight attitude of the drone, and the other can be used to control the gimbal camera, optical pod, and other payloads. In dual operator mode, two ground units can simultaneously acquire images from the same camera source, or display images from different camera sources separately.

*\*To use the "dual operator" function, you need to purchase a dual combo. Ordinary combos are not equipped with this function.*

## **Remote Control Relay, Remote Delivery**

Targeting the field of drone logistics, relying on wireless high-definition image transmission technology, SIYI has endowed the MK15 link with the feature of remote-control relay.

The "remote-control relay" function is developed for ultra-long-distance flight missions. It supports two ground units to relay control the same air unit to reach a maximum transmission distance twice that of a single standard transmission system.

It can be widely used in cruise line inspection, unmanned distribution, unmanned logistics and other fields.

*\*To use the "remote-control relay" function, you need to purchase a dual combo. Ordinary combos are not equipped with this function.*

### **Waterproof FPV Gimbal and FPV Camera**

When using MK15 for agriculture operations in complex and harsh environments, it is recommended to use the A2 mini waterproof ultra-wide-angle FPV gimbal. The large FOV allows you to have an unobstructed view. The drone can gain insight into the field conditions without adjusting its attitude during flight, helping the operator to make quick judgments and ensure work safety.

It can also be equipped with an IP67 waterproof camera with lights, which is not afraid of erosion and corrosion by chemical liquids, and fundamentally meets the needs of cleaning and maintenance.

### **Compatible with Popular Agriculture Flight Controllers and Drone Models**

After years of effort in the front-line market, the MK15 handheld ground station has won the praise of EFT, JIYI, VK-FLY, and BOYING, which are deeply rooted in the agriculture supply chain, with its excellent performance and reliable stability. Recognized by other core manufacturers, and deeply integrated and adapted with their major products, it allows users to get started faster, adapt and maintain more conveniently, and jointly build a complete ecosystem focusing on the long-term development and progress of the industry!

## 1.2 Parts

### 1.2.1 At a Glance



Overview – Remote Controller Front





Overview – Remote Controller Back

## 1.2.2 Button / Switch Types and Default Channel Definitions

MK15 remote controller comes with 13 physical channels and 16 communication channels in total. Communication channel 10 to 14 are also PWM channel 1 to 5 in default.

Channel No.	Physical Channel Type	Default Mapping	Remark
1	Aileron	Joystick J1	
2	Elevator (Mode 2)	Joystick J2	
3	Throttle (Mode 2)	Joystick J3	
4	Rudder	Joystick J4	
5		3-Stage Switch SA	
6		3-Stage Switch SB	
7		3-Stage Switch SC	
8		Button A	
9		Button B	
10		Button C	PWM 1
11		Button D	PWM 2
12		Left Dial LD	PWM 3
13		Right Dial RD	PWM 4
14			PWM 5
15			Searchlight A Gimbal Pitch
16			Searchlight B Gimbal Centering

### 1.2.3 Ports and Data Stream



### Ports on Remote Controller

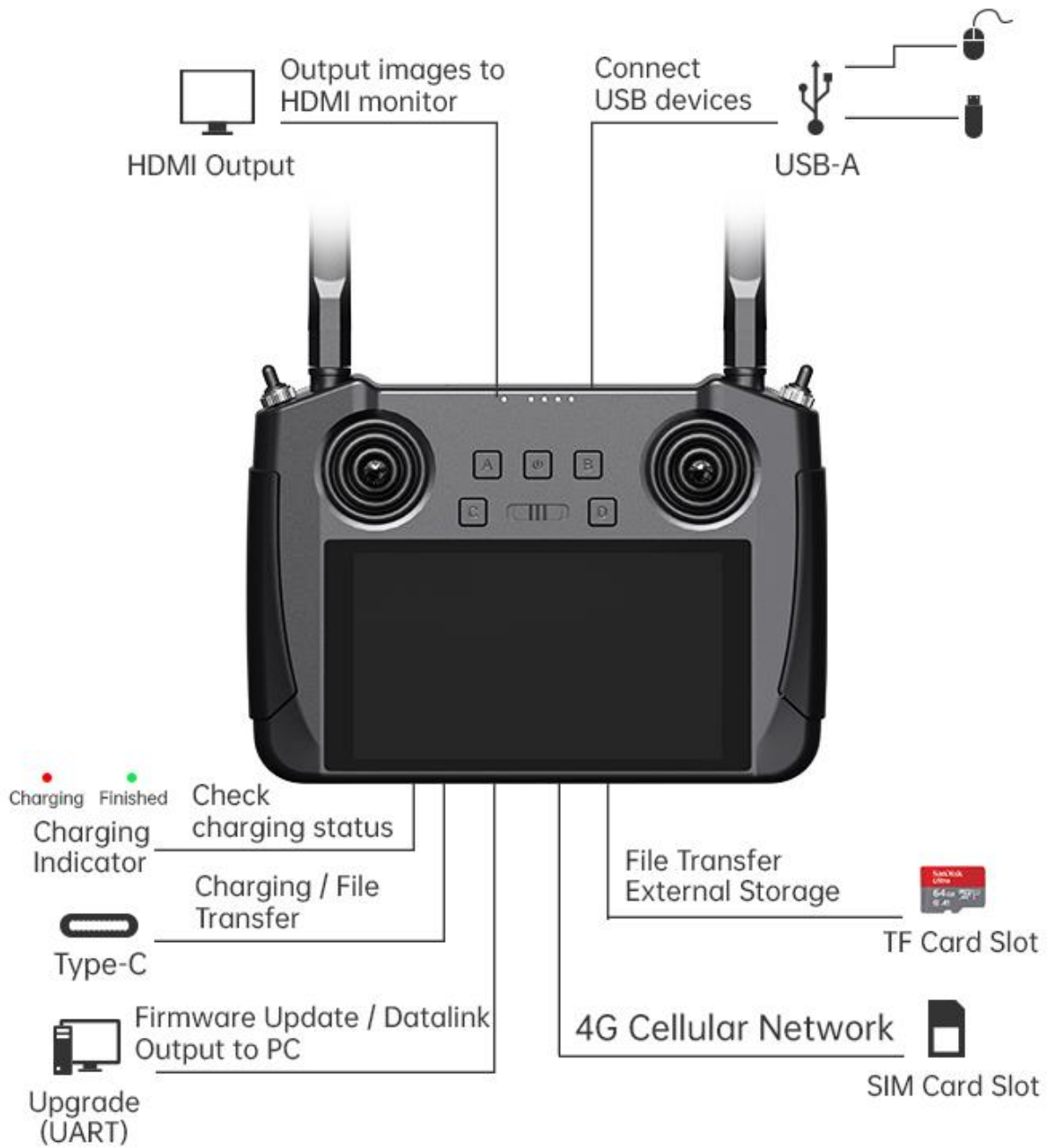

## Remote Controller Data Stream

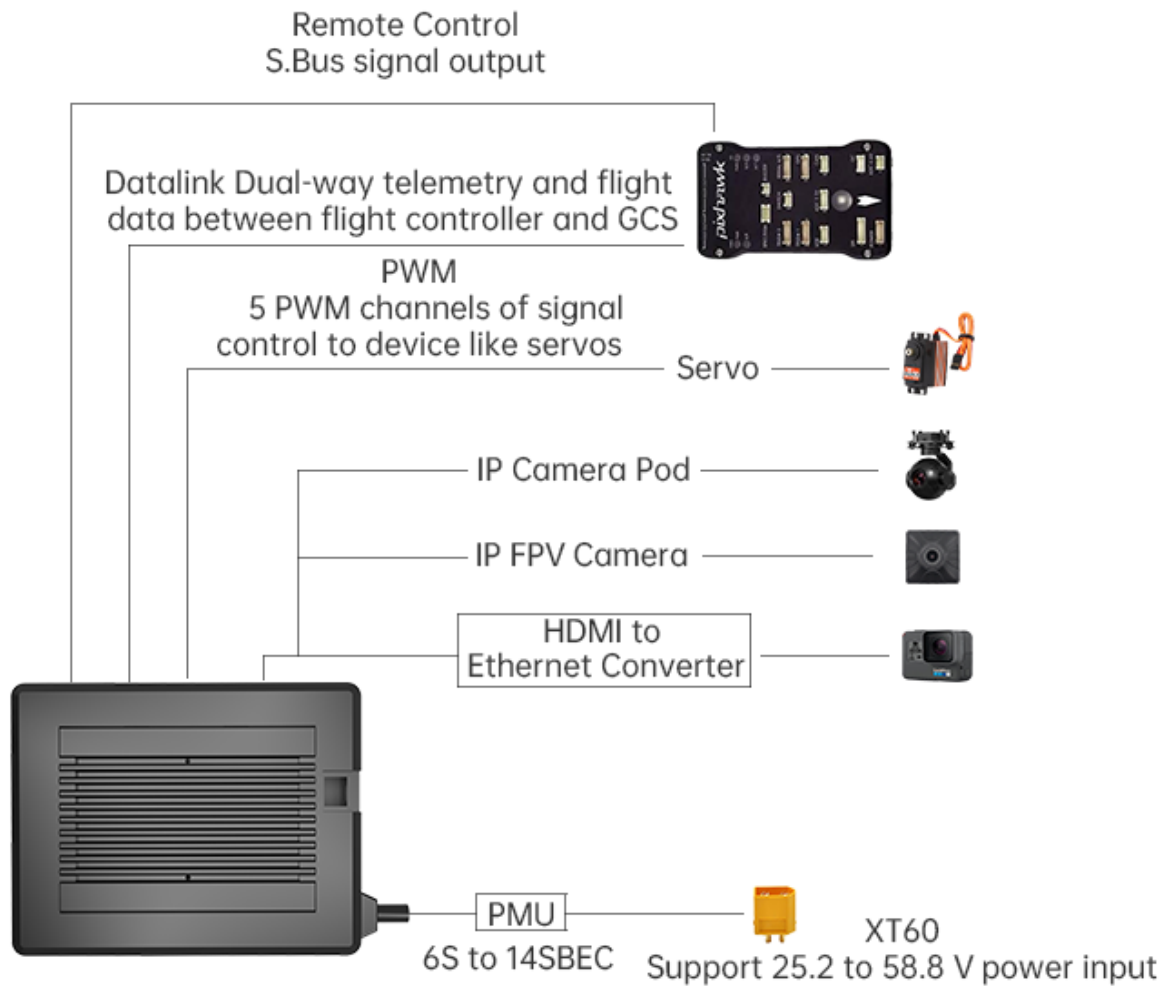

### Air Unit Data Stream



Welcome to contact SIYI to get the SIYI Air Unit 3D Model for pre-installation.

## 1.3 Technical Specification

### Overall

<b>Max Transmission Range</b>	15 km (Unobstructed, free of interference)
<b>Agriculture Drone Control Range</b>	3.5 km (Flying at 3-meter's altitude)
<b>Channels</b>	13 physical channels 16 communication channels
<b>Datalink Compatible Flight Controllers</b>	PX4 / Ardupilot Open-source Flight Controllers: SIYI N7, etc.  Agriculture Flight Controllers: BOYING Paladin V2 JIYI K++ V2 / K3A Pro VK V7AG / V9AG
<b>Video Stream Compatible Android GCS</b>	SIYI Original App: SIYI FPV  Open-source GCS: QGroundControl Mission Planner  Agriculture GCS: BOYING Agriculture JIYI Agri-Assistant / IFLY VK Agriculture
<b>Video Stream Compatible Windows GCS</b>	Open-source GCS: QGroundControl Mission Planner (H264 only)

### Remote Controller (Ground Unit)

<b>Monitor</b>	5.5-inch 1080p High Definition and High Brightness LCD Touchscreen
<b>System</b>	Android 9.0 OS 2G RAM, 16G ROM
<b>Battery Capacity &amp; Type</b>	10200 mAh 7.4V 2S Li-ion 75.48 Wh
<b>Fast Charging Protocol</b>	PD 20W
<b>Charging Time</b>	5 hours (PD 20W)

<b>Battery Life</b>	13 hours
<b>Antenna Gain</b>	Omni Antenna: 5 dBi Long Range Antenna: 11 dBi (included in enterprise edition) Lollipop Antenna: 5 dBi (optional)
<b>Interface &amp; Ports</b>	Video Output: Standard HDMI *Enterprise edition only External Device (Mouse, USB Disk): USB-A Charging: Type-C Firmware Upgrade: Upgrade Port (Bottom GH1.25 4Pin) File Transfer: Type-C / USB-A Mobile Network: SIM Card Slot External Storage: TF Card Slot Tripod Mount: 1/4-inch Standard Screw Hole
<b>Dimensions</b> (Antenna Overlapped)	189 x 138 x 41 mm
<b>Weight</b> (Antenna Overlapped)	850 g
<b>Waterproof Level</b>	IP53
<b>Working Temperature</b>	-10°C ~ 50°C

### Air Unit

<b>Signal Output</b>	16 channels of SBUS 5 channels of PWM
<b>Interface &amp; Ports</b>	S.Bus RC Signal Output: RC (GH1.25 3-Pin) Datalink (to FC): UART (GH1.25 4-Pin) PWM Channel 1 to 5: PWM (GH1.25 6-Pin) Video Input / Network Communication: LAN (GH1.25 8-Pin) Firmware Upgrade: Type-C
<b>Antenna Gain</b>	Omni Antenna: 5 dBi Lollipop Antenna: 5 dBi (optional)
<b>Working Voltage</b>	MK15 Air Unit (included in MK15 agriculture edition): 4S ~ 18S / 16.8 ~ 75.6 V (Early manufacturing lots support only 6S to 14S, please carefully confirm)  HM30 Air Unit (included in MK15 enterprise edition and MK32): 3S ~ 6S / 12.6 ~ 25.2 V (Early manufacturing lots of MK15 enterprise edition came with MK15 air unit) (Early manufacturing lots of HM30 air unit support only 3S to 4S, please carefully confirm)

	4S to 18S Power Module (included in MK15 enterprise edition and MK32): 16.8 ~ 75.6 V
<b>Power Consumption</b>	<p>MK15 Air Unit (included in agriculture edition):</p> <ul style="list-style-type: none"> <li>- Average: 3.2 W</li> <li>- Summit: 12 W</li> </ul> <p>HM30 Air Unit:</p> <ul style="list-style-type: none"> <li>- Average: 2.8 W</li> <li>- Summit: 12 W</li> </ul> <p>HM30 Air Unit + 4S to 18S Power Module:</p> <ul style="list-style-type: none"> <li>- Average: 3.2 W</li> <li>- Summit: 12 W</li> </ul>
<b>Dimensions</b> (Antenna Excluded)	70 x 55 x 16 mm (fan included)
<b>Weight</b> (Antenna Excluded)	<p>MK15 Air Unit (included in agriculture edition): 100 g</p> <p>HM30 Air Unit: 74 g</p> <p>HM30 Air Unit + 4S to 18S Power Module: 109 g</p>
<b>Working Temperature</b>	-10°C ~ 50°C

### Camera & LED Module

(Optional, Packed with Agriculture Combo)

<b>Camera Angle</b>	FOV 120°
<b>Working Voltage</b>	12 V
<b>Power Consumption</b>	LED OFF: 3 W LED ON: 8 W
<b>Luminous Flux</b>	1 W / 120 ~ 140 lm
<b>LED Type</b>	Transparent
<b>LED Angle</b>	120°
<b>Waterproof Level</b>	IP65



<b>Dimensions</b>	106 x 25 x 41 mm
<b>Weight</b>	108 g
<b>Working Temperature</b>	-10°C ~ 50°C

### Air Unit HDMI Input Converter

(Optional, Packed with Enterprise HDMI Combo)

<b>Video Input</b>	Micro HDMI
<b>Video Output</b>	Ethernet
<b>Working Voltage</b>	12 V
<b>Power Consumption</b>	3 W
<b>Video Recording Resolution</b>	1080p (1920*1080) @ 30 fps 720p (1280*720) @ 30 fps
<b>Recording Bitrate</b>	12 Mbps (H265 codec)
<b>File Storage Format</b>	FAT32
<b>Video Recording Format</b>	H265
<b>Supported TF / SD Card Type</b>	MicroSD Class10 Less than 32GB
<b>Dimensions</b>	42 x 41 x 11 mm
<b>Weight</b>	26 g
<b>Working Temperature</b>	-10°C ~ 50°C

### R1M Recording FPV Camera

(Optional)

<b>Video Output</b>	Ethernet
<b>Image Sensor</b>	1/2.9 Inch, 2 MP
<b>FOV</b>	Diagonal: 90° Horizontal: 80°
<b>Working Voltage</b>	12 V

<b>Power Consumption</b>	2.5 W
<b>Video Recording Resolution</b>	1080p (1920*1080) @ 30 fps 720p (1280*720) @ 30 fps
<b>Recording Bitrate</b>	12 Mbps
<b>Video Recording Format</b>	MP4
<b>Supported TF / SD Card Type</b>	MicroSD Class10 Less than 32GB
<b>File Storage Format</b>	FAT32
<b>Dimensions</b>	42 x 42 x 25 mm
<b>Weight</b>	23 g
<b>Working Temperature</b>	-10℃ ~ 50℃

## 1.4 Packing List

### Agriculture Edition

Agriculture FPV Gimbal Sales Bundle	Agriculture FPV Sales Bundle	Agriculture Dual FPV Sales Bundle
1 x MK15 Agriculture Remote Controller 2 x Standard Omni Antenna		
1 x MK15 Air Unit 2 x Standard Omni Antenna		
1 x A2 mini FPV Gimbal	1 x IP67 FPV Camera (A)	1 x IP67 FPV Camera (B) 1 x FPV Hub
1 x PX4 / Ardupilot Standard Telemetry Cable 1 x S.Bus Cable (Male) 1 x PWM Cable 1 x Ethernet Cable		
1 x 20W PD Fast Charger (Type-C, US Plug) 1 x PD Fast Charging Cable (Type-C to Type-C) 1 x Type-C to USB-A Converter		
1 x Carrying Case		

### Mark

Agriculture flight controllers like BOYING, JIYI, and VK need special telemetry cable. BOYING and VK flight controllers also need special S.Bus cable. Please do instruct your reseller or your SIYI sales representative before purchasing.

### Enterprise Edition

Enterprise Standard Combo	Enterprise HDMI Combo
1 x MK15 Enterprise Ground Unit 2 x Standard Omni Antenna 2 x Long Range Antenna	
1 x HM30 Air Unit 1 x 4S to 18S Power Module 2 x Standard Omni Antenna	
	1 x Air Unit HDMI Input Converter
1 x PX4 / Ardupilot Standard Telemetry Cable 1 x S.Bus Cable (Male) 1 x PWM Cable 1 x Ethernet Cable	
1 x 20W PD Fast Charger (Type-C, US Plug) 1 x PD Fast Charging Cable (Type-C to Type-C) 1 x Type-C to USB-A Converter	
1 x Carrying Case	

### Mark

The major difference between agriculture edition and enterprise edition are:

1. Agriculture remote controller come with no HDMI output.
2. The communication range of agriculture edition is mostly optimized for ground-to-ground transmission, while the range of enterprise version is mostly optimized for ground-to-air transmission.

## Dual Edition

Dual Combo
2 x MK15 Enterprise Ground Unit (Dual Edition) 4 x Standard Omni Antenna 4 x Long Range Antenna
2 x HM30 Air Unit (Dual Edition) 2 x 4S to 18S Power Module 2 x Standard Omni Antenna
2 x PX4 / Ardupilot Standard Telemetry Cable 2 x S.Bus Cable (Male) 2 x PWM Cable 2 x Ethernet Cable
2 x 20W PD Fast Charger (Type-C, US Plug) 2 x PD Fast Charging Cable (Type-C to Type-C) 2 x Type-C to USB-A Converter
2 x Carrying Case

### Mark

The major difference between dual edition and normal edition are:

Dual edition comes with “Dual Operator” and “Remote Control Relay” features. Normal edition does not.

## 1.5 Status Indicator Definition

The status indicators on remote controller and air unit use three different colors and different blinking frequencies to indicate the system's working or abnormal status.





### 1.5.1 Transmitter Indicator

- Solid Red: No communication between transmitter and Air Unit.
- Fast Red Blinks: Transmitter is binding to Air Unit.
- Slow Red Blinks: Firmware does not match.
- ● ● Triple Red Blinks: Image transmission initialization failed.
- ● ● ● Four-time Red Blinks: Transmitter requires calibration.
- ● ● ● Red-Green-Red-Green-Red Blinks: Unexpected power off of MK15 Android system.
- Slow Yellow Blinks: Transmitter power voltage abnormal.
- ○ Double Yellow Blinks: Transmitter Bluetooth is not identified.
- ● Yellow-Red Blinks: Transmitter high-temperature alert, level one.
- ● ● Yellow-Red-Red Blinks: Transmitter high-temperature alert, level two.
- ● ● ● Yellow-Red Blinks: Transmitter high-temperature alert, level three.
- Solid Green: Perfect communication, receiving 100% data package.
- Green Blinks: Blinking frequency indicates the system's signal quality. More frequently it blinks, worse the signal quality is.
- Slow Green Blinks: Receiving 95% to 99% data package.

- Green Blinks (every 3/5 second): Receiving 50% to 75% data package.
- Green Blinks (every 3/10 second): Receiving 25% to 50% data package.
- Green Blinks (every 1/25 second): Receiving less than 25% data package.
- ● Green-Red Blinks: Air Unit high-temperature alert, level one.
- ● ● Green-Red Blinks: Air Unit high-temperature alert, level two.
- ● ● ● Green-Red Blinks: Air Unit high-temperature alert, level three.
- ● ● Slow Red-Green-Yellow Blinks: Image transmission is starting.

### 1.5.2 Air Unit Indicator

- Solid Red: No communication between transmitter and Air Unit.
- Fast Red Blinks: Transmitter is binding to Air Unit.
- Slow Red Blinks: Firmware does not match.
- ● ● Triple Red Blinks: Image transmission initialization failed.
- Yellow Blinks: Low voltage alert (voltage input from PMU is lower than 12V).
- Solid Green: Perfect communication, 100% data package received.
- Green Blinks: Blinking speed indicates MK15 system's signal strength. The faster it blinks, the worse the signal is.
- Slow Green Blinks: 95% to 99% data package received.
- Green Blinks (every 3/5 second): 50% to 75% data package received.
- Green Blinks (every 3/10 second): 25% to 50% data package received.
- Green Blinks (every 1/25 second): less than 25% data package received.
- ● Green-Red Blinks: Air Unit high-temperature alert, level one.

-  Green-Red Blinks: Air Unit high-temperature alert, level two.
-  Green-Red Blinks: Air Unit high-temperature alert, level three.
-  Fast Green-Red-Green-Red-Green-Red Blinks: Wireless binding is starting (activated by power on/off three times).
-  Slow Red-Green-Yellow Blinks: Image transmission is starting.



## 2 GET READY TO USE

### 2.1 Remote Controller

#### 2.1.1 Power On / Off

Power On:

When the remote controller is off power, press the power button once, battery level indicators light on. Then immediately press and hold the power button for about two seconds, battery indicators will light on again but one by one this time. And remote controller is powered on.

Power Off:

When the remote controller is working, press and hold the power button for about two seconds, remote controller monitor will pop up a window with some buttons. Tap the power-off button to power off the ground unit.



#### CAUTION

**Mandatory Power Off:** When the remote controller is working, press and hold the power button for about eight seconds, ground unit will be forced to power off.



#### Mark

**Screenshot:** When the remote controller is working, press and hold the power button for about two seconds, remote controller monitor will pop up a window with some icons. Touch the screenshot icon to make a screenshot of current screen display.

Screen Off: When the remote controller is working, press the power button once, remote controller monitor will be off for energy saving.

### 2.1.2 Charging

You can charge the remote controller only when it is powered off and only by using the original PD fast charger.

1. Connect the remote controller to the PD charger and plug it into power supply.
2. The charging indicator lights on red, ground unit starts charging.
3. The charging indicator lights on green, charging is finished.



### CAUTION

Normal 5V charger adapter cannot charge the remote controller, please do use SIYI original PD fast charger.

MK15 remote controller cannot be charged when it is working. Please do power off the remote controller before charging.

### 2.1.3 Charging Indicator

- Solid Red: Remote controller under charging.
- Solid Green: Charging finished.

## 2.1.4 Change System Language

MK15 Android system supports almost all available languages, which can be switched in system settings easily.

### Mark

The factory language of MK15 Android system is “Chinese (Simplified)”.

### Steps

1. Go to Android system settings.



2. Slide down to find “System (Language, Time, Backup, Update)” and enter.



3. Go to “Language and Input” and choose “Language”, then “Add Language”.

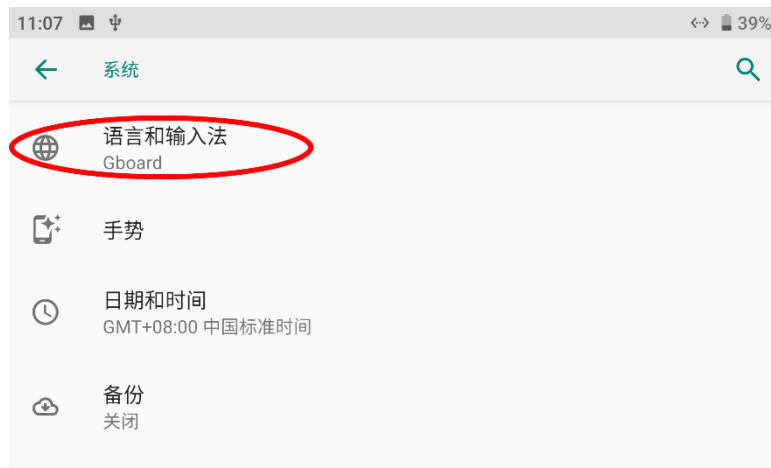

4. Let's take an example of “English (US)”. Slide down to find “English”, then choose “United States”. The page will jump back to “Language and Preference”.

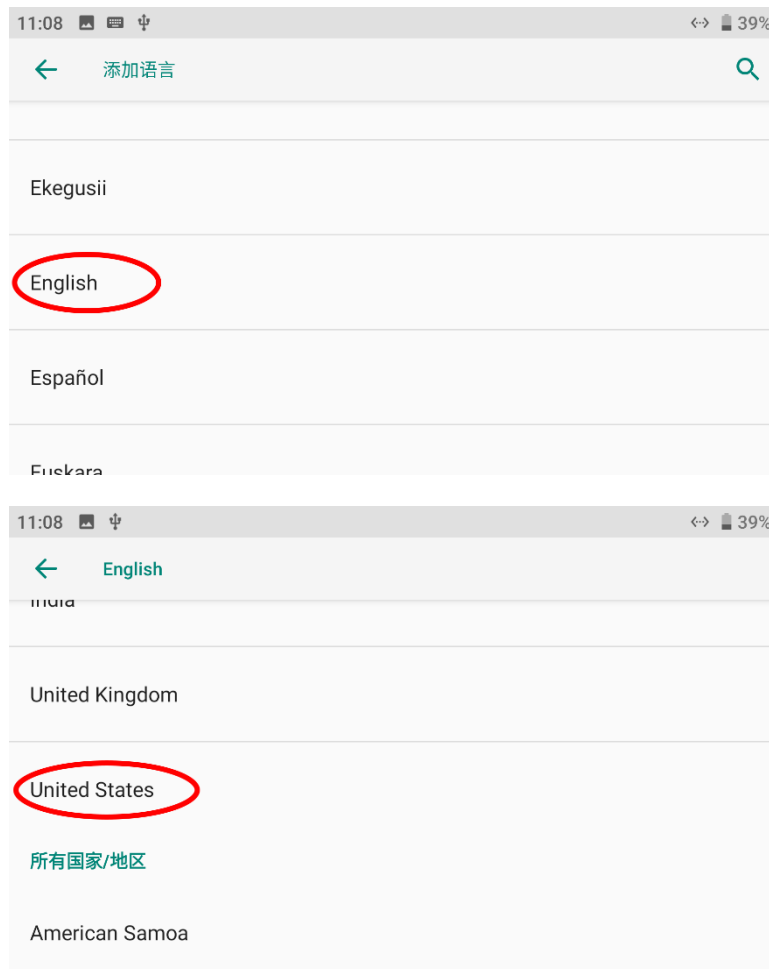

5. Drag the just added “English (US)” language bar to the first line, system language will change to English (US) automatically.

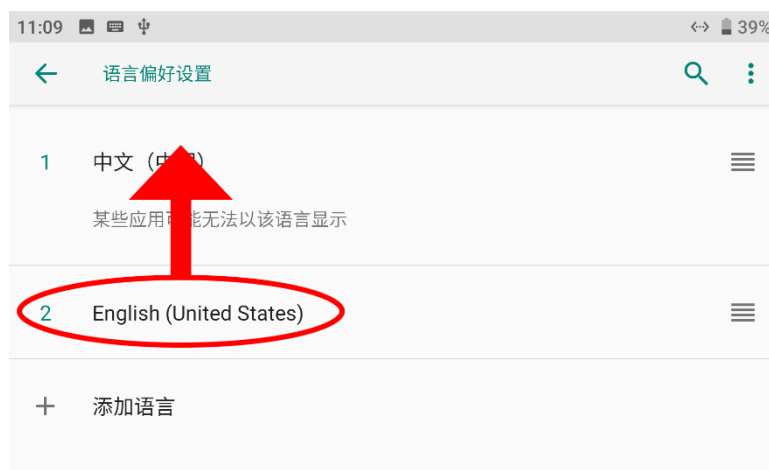

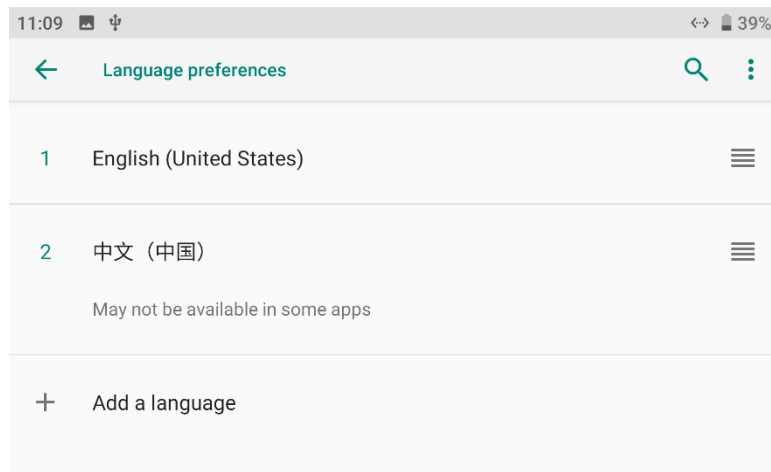

## **2.2 Important Instructions on Promotion to Communication Range and Video Fluency**

To have the best communication range and video fluency with MK32 / MK15 system, please carefully read the below tips for antenna options, antenna setup, and link configuration.

### **2.2.1 General Precautions**

1. It is suggested that not to run SIYI FPV app and QGroundControl app simultaneously with video streaming, not even running one at backstage, as it still occupies bandwidth thereby lower the communication range.
2. Only power batteries are allowed to power the air unit. HD image transmission system requires very high standard to the current of power supply, the instancy of the current response, and the current ripple. Power supply from the third-party power module, modified power module or from PDB may interfere the link stability and the communication range. If you do not need the power module, it is suggested that you use the HM30 air unit.

## **2.2.2 General Antenna Options and Wireless Mode Configuration for Different Range**

### **1. 0 to 10 Kilometers Range**

Two standard omni antennas on ground unit.

Wireless mode: 5 km or 8 km low latency.

### **2. 10 to 15 Kilometers Range**

Two standard omni antennas or two standard long-range antennas on ground unit.

Wireless mode: 15 km GCS.

### **3. 15 to 30 Kilometers GCS Flight**

Two standard long-range antennas or higher gain patch antennas on ground unit.

Wireless mode: 24 km GCS.

4. The signal at the top of the standard omnidirectional antenna is weak. When flying directly above the ground, the flying height of the aircraft should be as low as 100 meters.



5. When the ground unit is working with long range antennas or patch antennas, the aircraft should always be in front of the antenna panel instead of being vertical of the antenna or on opposite.
6. Only the standard omni antennas are suggested for the air unit. If your aircraft is too small to mount the omni antennas, or you worry about the weak signal of the top part, then you can consider using SIYI lollipop antennas. Lollipop antennas performs shorter range than the standard omni antennas.

### 2.2.3 How to Place the Standard Omni Antennas on Ground Unit

1. The SMA connectors should be screwed tightly.
2. The antennas should stand vertically from the control panel of the ground unit, and the antennas' flat side should always point to the aircraft or the vehicle. Do not cross or overlap the antennas during mission.



## **2.2.4 How to Place the Long-Range Patch Antennas on Ground Unit**

1. The SMA connectors should be screwed tightly.
2. Long-range patch antennas are directional, which should always be pointing to the aircraft during flight.
3. When you are using SIYI standard long-range antennas, please make its short side be parallel with horizon and its long side be vertical of the control panel to get the best signal quality.

## **2.2.5 How to Place Air Unit Antennas**

1. The SMA connectors should be screwed tightly.
2. On multicopter, the standard omni antennas should be hanging vertically from the drone arms with the antenna heads pointing to ground, and the antenna flat side should always point to the ground unit during flight. On plane, the standard omni antenna can stand vertically above the wings, and the antenna flat side should always point to the ground unit during flight.
3. The air unit antenna feeder wire should be placed away from E.S.C and motors, and any other equipment with heavy current or interference. Do not cross or overlap the antenna feeder wires.
4. The antenna body, feeder wire, and the SMA connectors should not touch the metal / carbon-fiber structure parts directly. Please reserve at least 10 mm

distance between these parts and the structure parts.

5. The two air unit antennas should be placed away from each other for at least 50 mm distance. And try your best to avoid any kinds of obstruction between the ground unit and the aircraft during flight.
6. Please be very careful with the antenna wire's SMA connectors and its solder connectors. Do not drag them or bend them in case of any damage. To adjust the position of the antenna, please always try to bend the middle part of the antenna feeder wires.

## CAUTION

As shown in the picture below, for small and medium-sized multi-rotor drones, the air unit antenna should be placed downward perpendicular to the arm to keep the flat surface of the antenna facing the direction of the remote controller.



As shown in the figure below, for large multi-rotor drones, the air unit antenna should be placed vertically downwards from the motor base to keep the flat surface of the antenna facing the direction of the remote control.



As shown in the figure below, for fixed-wing aircraft, the air unit antenna can be placed vertically to the wings or vertical tail upwards and try to keep the flat surface of the antenna facing the direction of the remote controller.

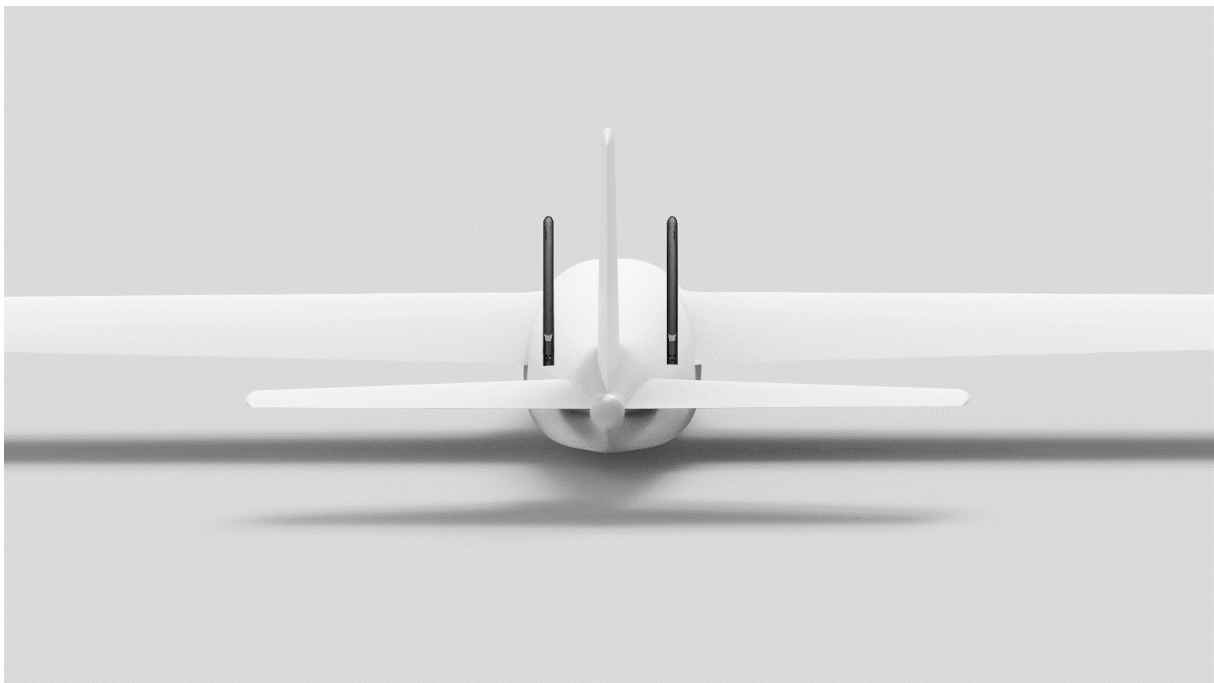
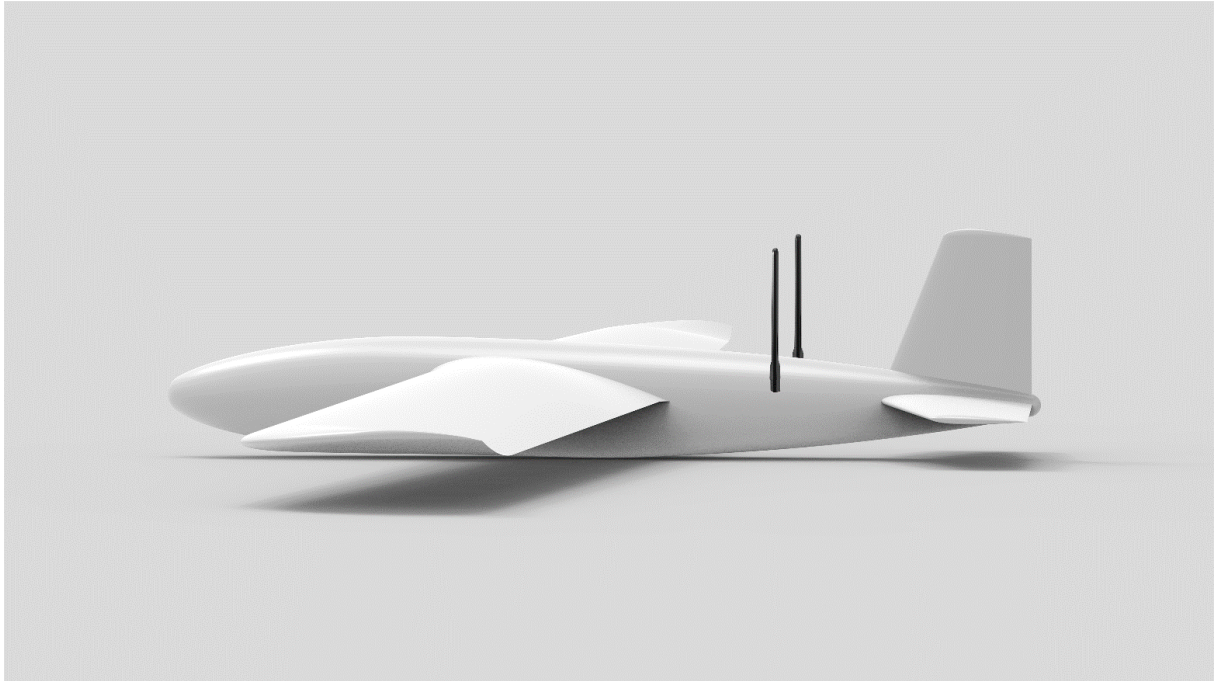

## 2.2.6 The Communication Range Is Not as Expected and You Need Factory Support, Here Are the Necessary Information We Need

1. The obvious things that make you think about range is not good.
  - Signal Loss: Image disappears, and RC status indicator is red.
  - Only image disappears (RC status indicator is green).
2. Flight altitude and distance of your drone when you observe the above things.
3. Flight test environment (pictures or videos taken in the orientation of the flight).
4. Check software information relevant to communication.

- Wireless Mode

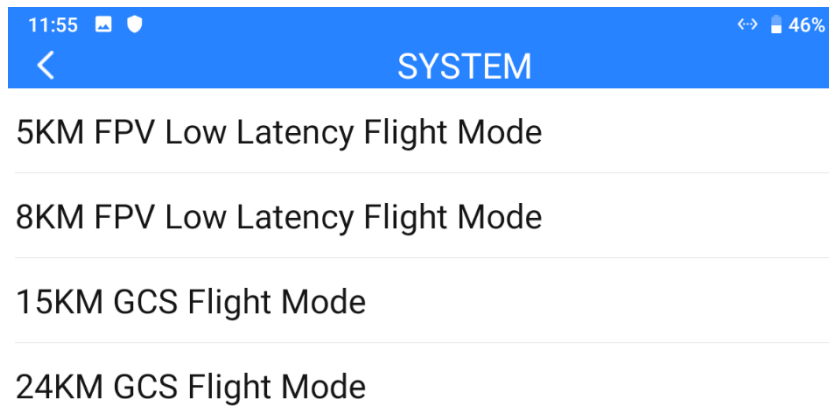

- Ground and Air Unit Firmware Version

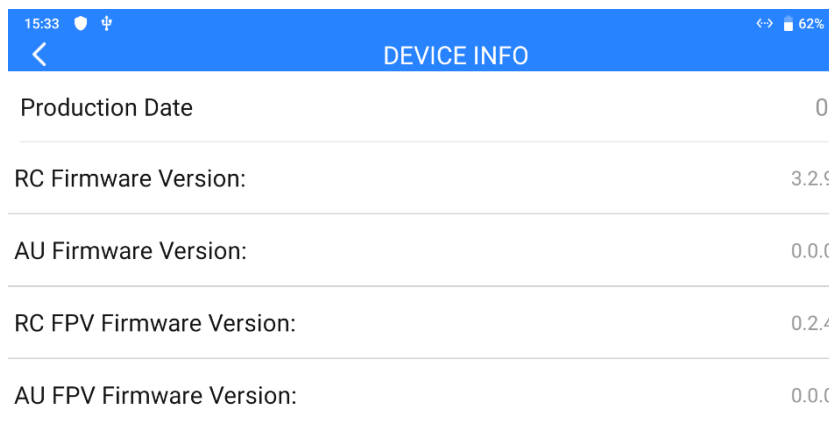

- SIYI FPV app version



5. Check hardware configuration relevant to communication.
  - Ground Unit Antenna Type, Antenna Installation, Operating Angle (all with pictures)
  - Air Unit Antenna Type, Antenna Installation (both with pictures)
  - Air Unit Power Supply / Voltage and if the original BEC is removed / modified.
6. If all above trouble shooting still didn't help find the cause to unexpected range, please provide a screenshot of SIYI FPV app with all OSD turned on when the drone is flying closely to the range limit that you have experienced, or provide a screen recorded video of the running SIYI FPV app during the whole flight.

## 3 SIYI TX APP

Users can configure remote controller in “SIYI TX” app.

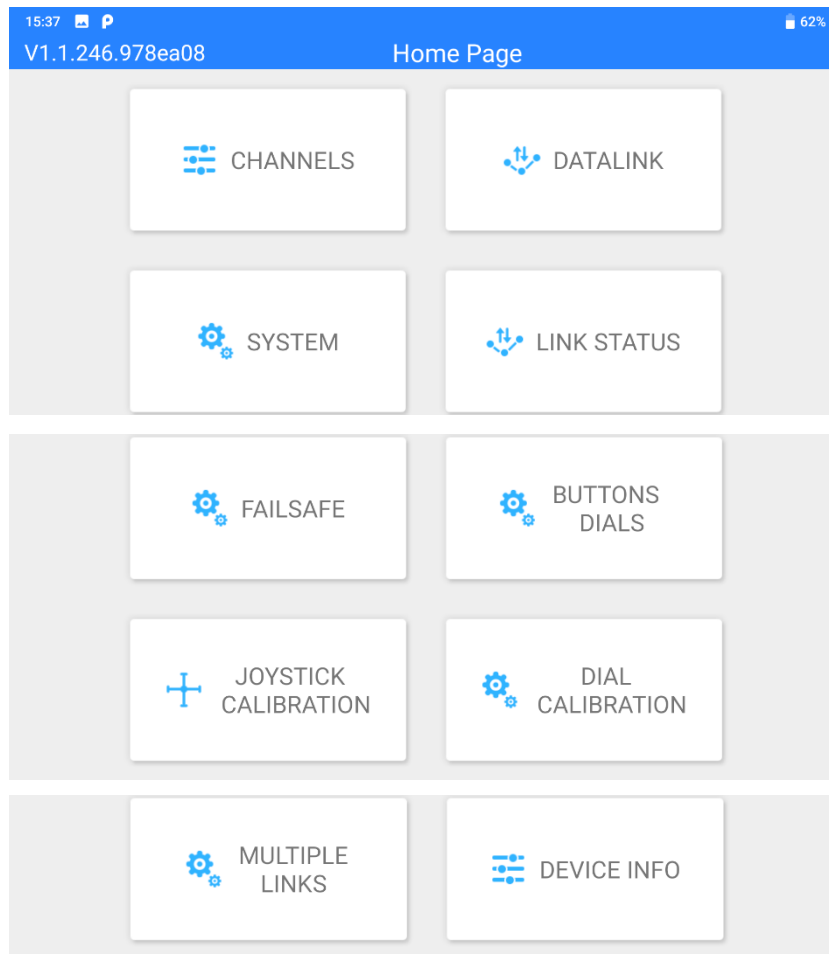

### Mark

This chapter was made according to “SIYI TX” v1.1.246.

### 3.1 Channels

Channel settings of End Point, Middle Point, Channel Reverse, and Channel Mapping.



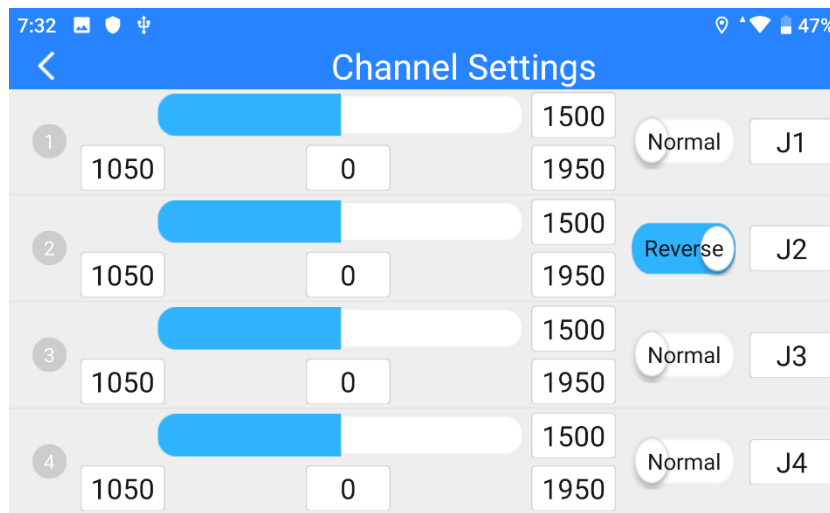

### 3.1.1 End Point

Remote controller's default end point range is between 1050 and 1950.

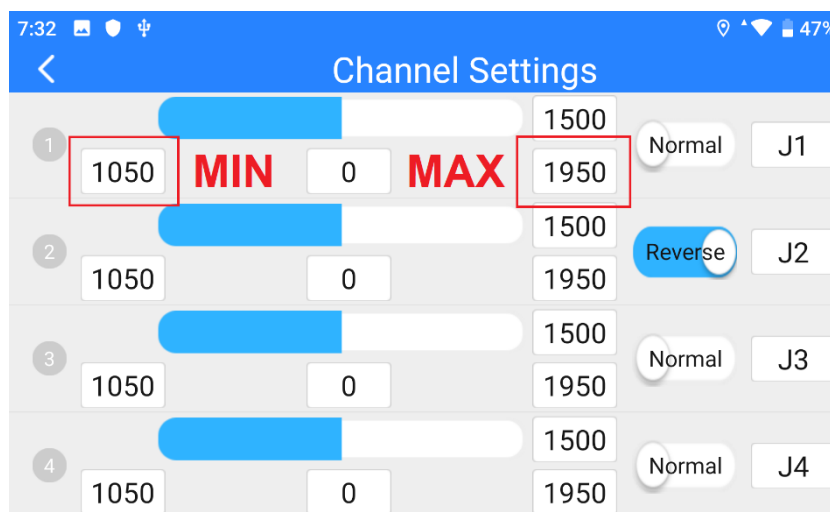

Select a target channel and input your required maximum or minimum channel value. It's done.

### 3.1.2 Middle Point

The default Middle Point value is “1500”.

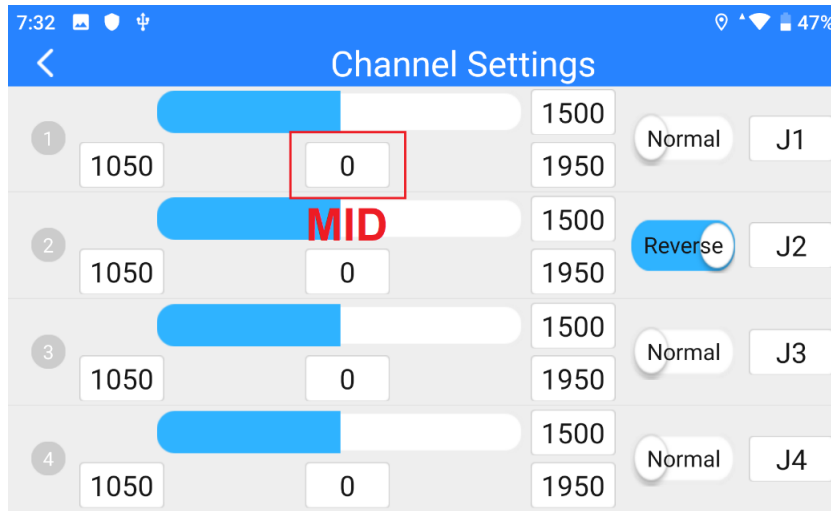

Select a target channel and input your required middle point value. It's done.

### 3.1.3 Channel Reverse

Channel Reverse is to reverse a channel's output direction.

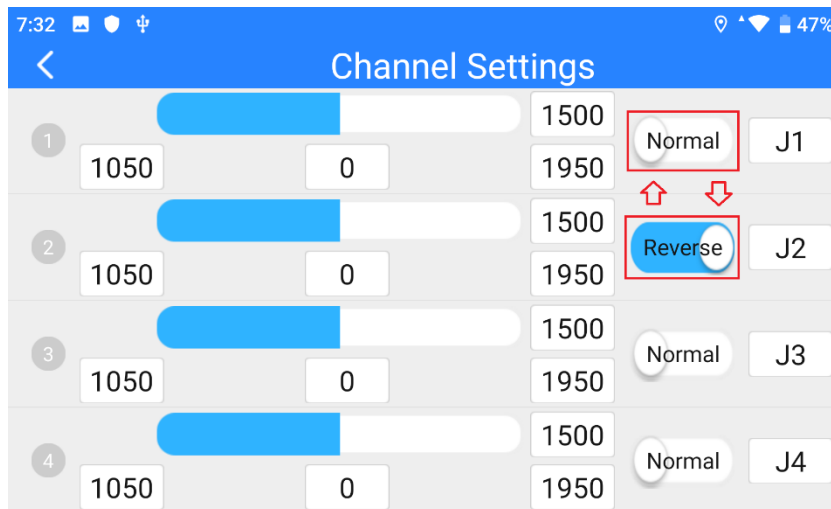

Select a target channel. Then touch the “Normal” or “Reversed” button. It's done.

### 3.1.4 Channel Mapping

MK15 remote controller has 13 physical channels, an RSSI channel, and 16 communication channels. Users are allowed to define or to map the physical channels (buttons, switches, joysticks) and the RSSI channel to the communication channels freely.

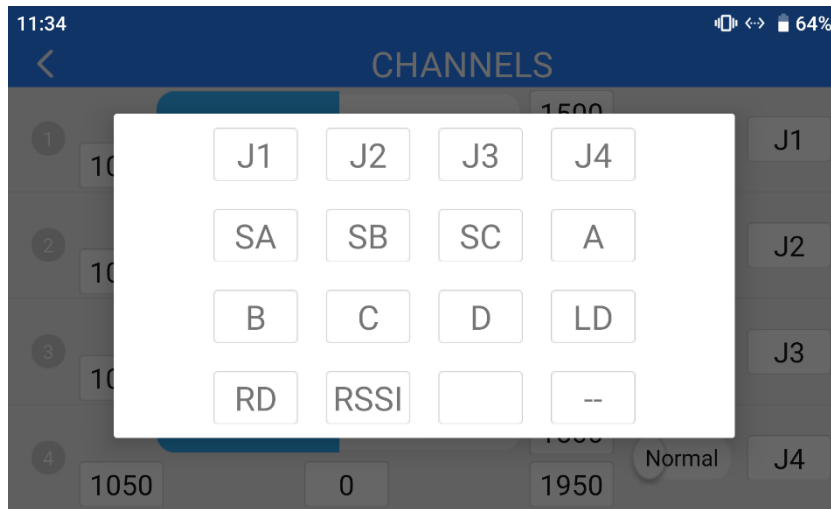

Select a target channel. Then touch a mapped button / switch / joystick, it will pop up a list of all physical channels. Select the button / switch / joystick you want to re-map to. It's done.

## 3.2 Datalink

In Datalink Settings you can check the device ID, switch datalink connection and flight controller type, and configure customized baud rate.

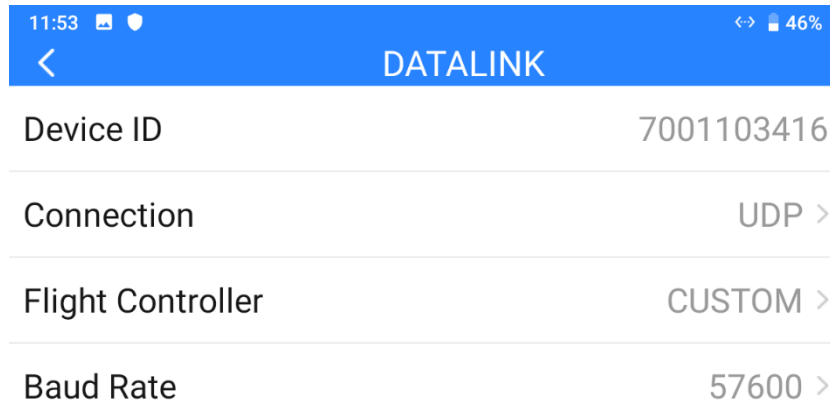

### About Datalink Settings

**Device ID:** Display the device ID of the integrated Bluetooth module in remote controller.

It also shows as the Bluetooth name before pairing.

**Connection:** Available datalink ports in remote controller.

**Flight Controller:** Compatible flight controller models by remote controller.

**Baud Rate:** The baud rate here must match the baud rate of PX4 / Ardupilot flight controller TELEM port which is used for datalink and configured in GCS.

### 3.2.1 Connection

Available datalink connection types in MK15 remote controller are: UART, USB COM, Bluetooth, Upgrade Port, and UDP.

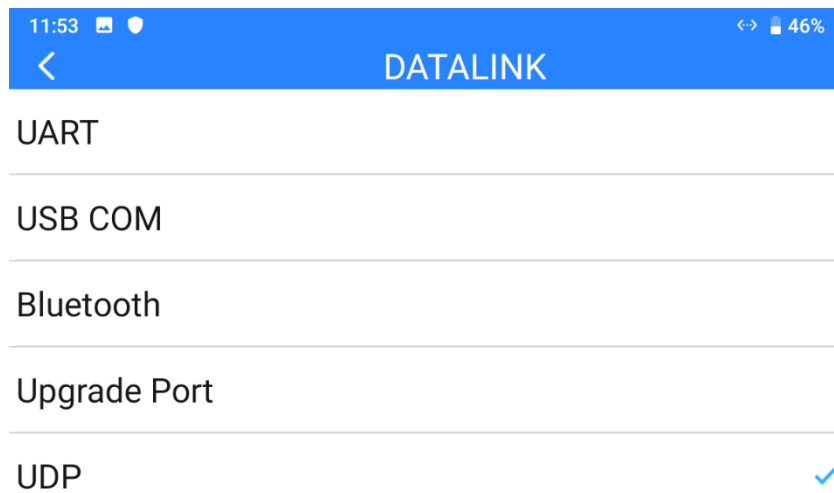

### About Datalink Connection

UART: Telemetry data goes through the built-in UART port in the remote controller.

\*Compatible with specific Android GCS, such as BOYING, JIYI, and VKFLY.

\*Developers can acquire SDK from SIYI to use the port for their GCS.

USB COM: Telemetry data goes through the built-in CP2102 port in the remote controller.

\*Compatible with Android QGroundControl.

Bluetooth: Telemetry data goes wirelessly through the built-in Bluetooth connection.

\*Compatible with most Android and Windows GCS.

Upgrade Port: Telemetry data goes to Windows GCS through the bottom upgrade port on MK15 remote controller.

UDP: Telemetry data goes through UDP network protocol.

### 3.2.2 Flight Controller

Select your required flight controller type for datalink connection in the provided list.

Currently supported flight controller models are: SIYI N7 Autopilot, PX4 / Ardupilot Flight Open-source Controllers, JIYI (K3A or K++), BOYING (Paladin), VKFLY (V7AG) agriculture flight controllers, and customized flight controllers.

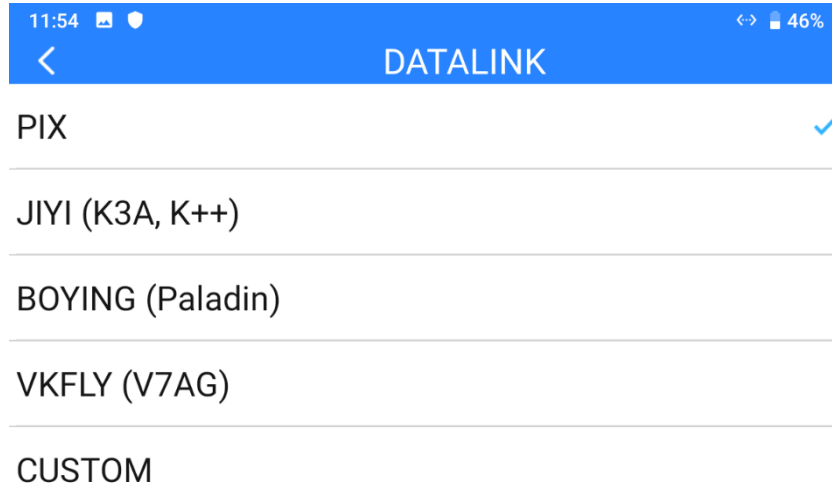

 **Mark**

Please make sure that the remote controller has been bound to the air unit before switching flight controller type, otherwise it would fail.

### 3.2.3 Baud Rate

If your flight controller model was not found in the list, please choose “Custom” and manually configure the baud rate of your flight controller in this page.

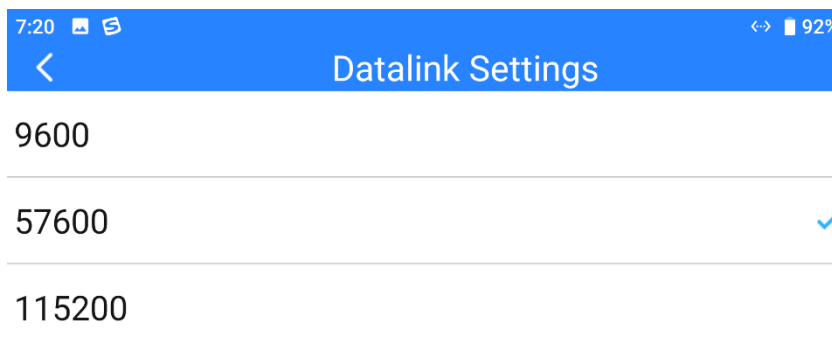

 **Mark**

Please make sure that the remote controller has been bound to the air unit before configuring baud rate, otherwise it would fail.

### 3.3 System

Configure some important system functions for MK15 system.

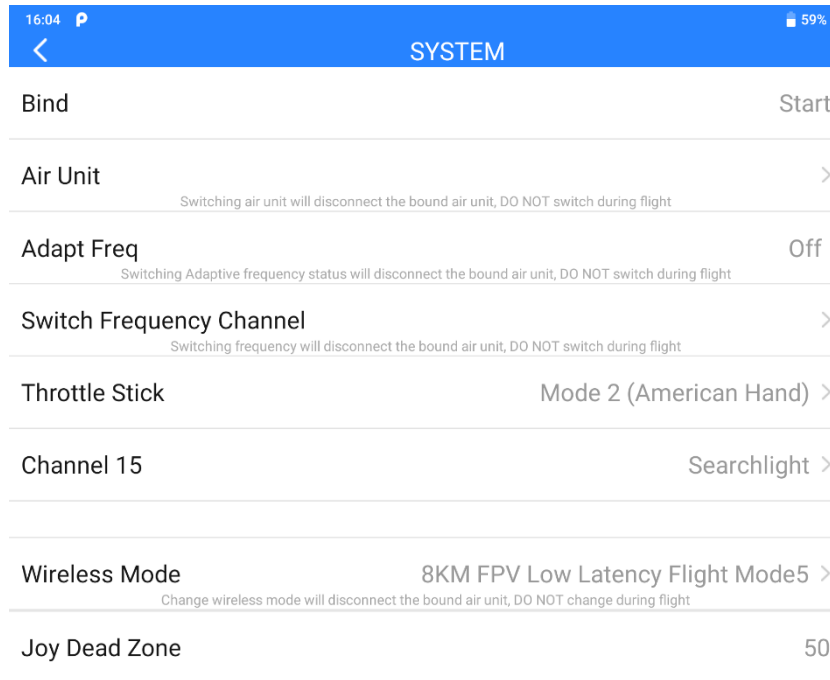

#### About System Settings

**Bind:** Check current binding status or start binding process on remote controller.

**Multiple Air Unit:** Remote controller can save up to five bound air units for switching quickly with no need to bind them again.

**Adapt Frequency:** When binding, remote controller searches and switches to the frequency band with lowest interference automatically.

**Switch Frequency Channel:** Manually switch the working frequency to a channel.

**Throttle Stick:** Switch throttle types among Mode 1, Mode 2, Mode 3, and Custom.

**Channel 15:** Switch controlling channel 15 between the searchlight switch of the IP67 camera and the pitch axis rotation of the A2 mini gimbal.

**Wireless Mode:** Switch wireless mode for different communication range.



Joystick Deadzone: Configure the joystick deadzone value for smooth control based on your habit.

### 3.3.1 Bind

Please follow the steps below to bind the ground unit to the air unit.

1. In “SIYI TX” application, go to “System” page, then touch “Bind - Start”.
2. Ground unit status indicator will turn to “Red Fast Blinking”. And in “Bind” menu, it displays “Binding”.
3. Press and hold the binding button on the air unit for about two seconds, air unit status indicator will turn to “Red Fast Blinking” as well.
4. Then wait for 5 to 10 seconds till both ground unit and air unit status indicators have turned to “Solid Green”. Binding is done.

### 3.3.2 Multiple Air Unit

The multiple air unit function supports saving multiple bounded air unit and corresponding channel setting data on the same remote control. In this way, after each air unit and remote controller are bound for the first time, users no longer need to re-bind to switch between them.

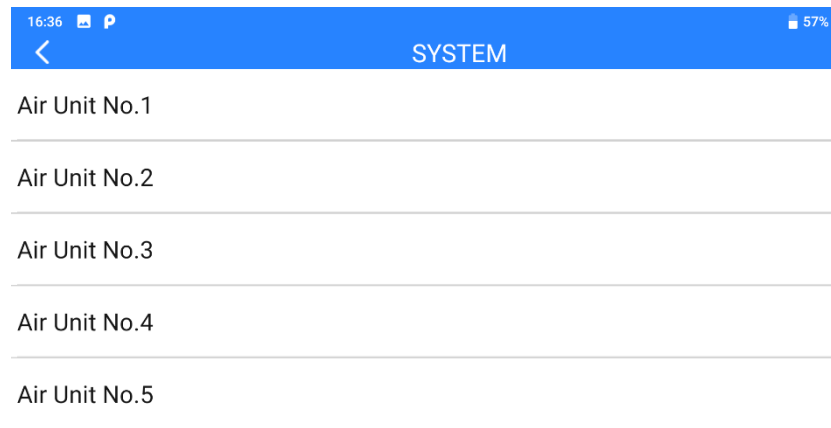

## DANGER

It is forbidden to switch the air unit during flight. Switching the air unit during flight will cause the link to go out of control!

### 3.3.3 Frequency Self-Adapting

In strong-interference environment, turn on the function, remote controller will automatically search for the frequency band with least interference to get the best transmission quality.

## Mark

After turning on the function in “SIYI TX”, please restart the remote controller, otherwise it would fail.

### 3.3.4 Throttle Stick

Switch throttle joystick type. Available types are Mode 1 (Japanese Hand), Mode 2 (American Hand), Mode 3 (Chinese Hand), and Customize Hand.

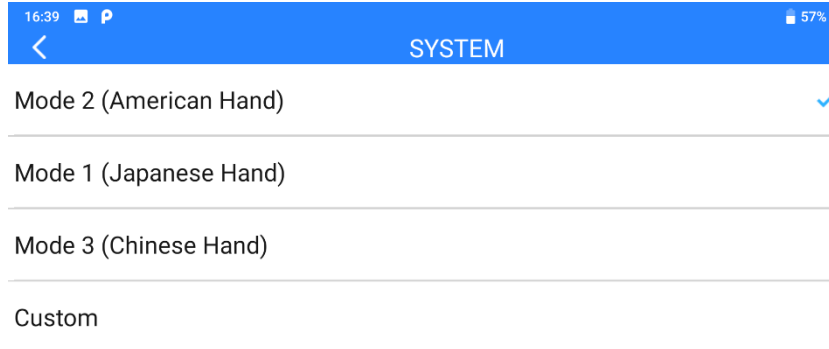

### 3.3.5 Channel 15

Switch controlling channel 15 to the IP67 camera's searchlight function or the A2 mini gimbal's pitch axis rotation.

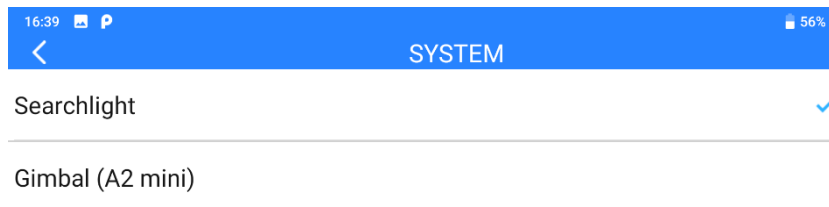

### 3.3.5 Wireless Mode

SIYI link supports switching wireless communication modes and cooperates with different types and different gain antennas to achieve the conditions most conducive to wireless communication and the ultimate communication distance.

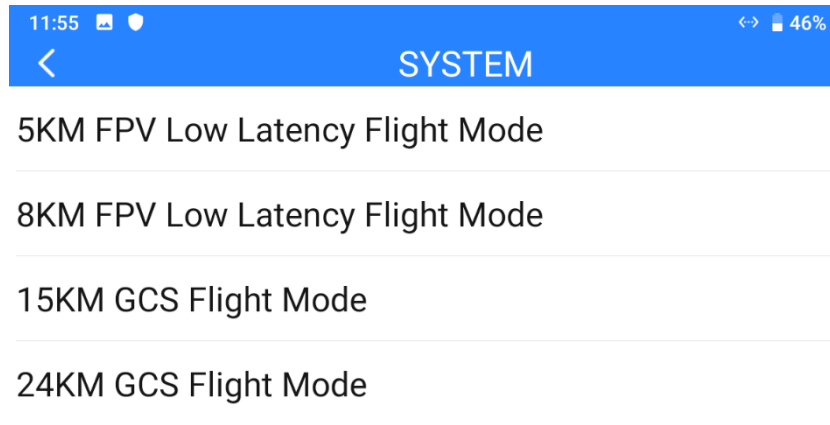

**Mark**

Before configuring wireless modes, please carefully read the chapter 2.2 in this manual “Important Instructions on Promotion to Communication Range and Video Fluency”.

### 3.3.7 Joystick Deadzone

Adjust the joystick dead zone to adapt to various control feels.

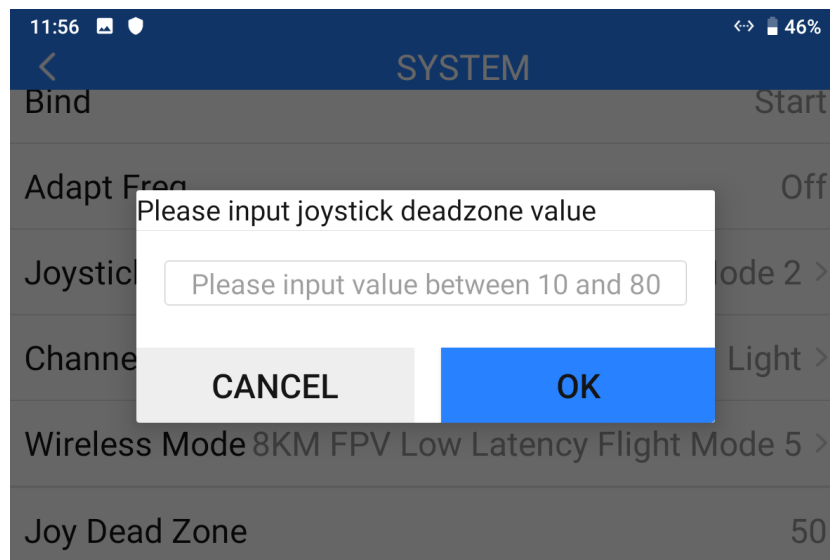

### 3.4 Link Status

Link Status page digitalized the system’s transmission quality by displaying the link’s real-time status in numbers and percentage.

LINK STATUS	
Frequency	2
Loss Rate	0%
Valid Package	2
Valid Package Rate	2%
Data Upload	0
Data Download	0

#### About Link Status

**Frequency:** The current frequency that the system is working at.

**Loss Rate:** Loss percentage of data package which failed to be received by the ground unit per second.

**Received Pack:** Quantity of data package which are successfully received by the ground unit per second.

**Received Rate:** Received percentage of data package which are successfully received by the ground unit per second.

**Upload:** Data uploaded to the air unit per second by bit.

**Download:** Data downloaded from the air unit per second by bit.

### 3.5 Failsafe

After finishing binding the ground unit to the air unit for the first time, please do configure the system with Failsafe function immediately.

Failsafe function is to avoid aircraft crash by keeping the air unit outputting the pre-configured channel value when the air unit lost communication with the ground unit.

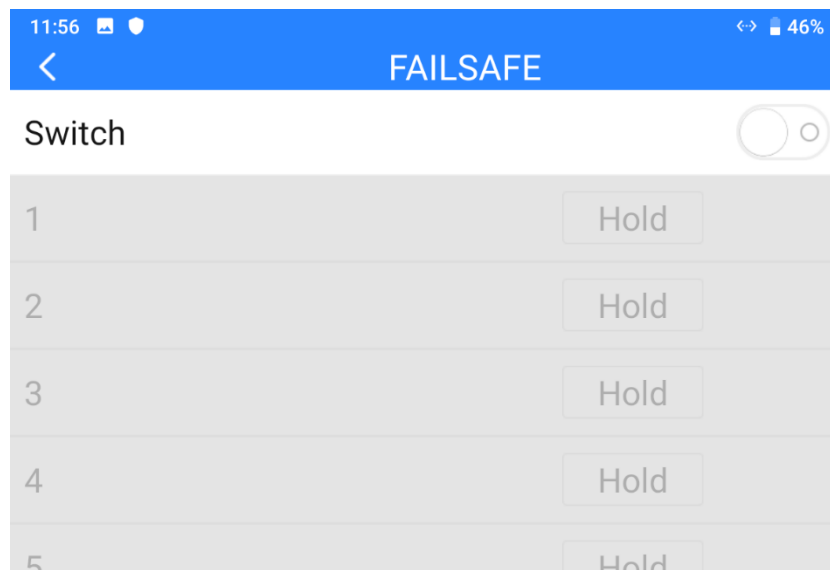

Please follow the steps below to configure your system with Failsafe function.

1. Make sure that the ground unit is bound to the air unit.
2. Go to “Failsafe” page.

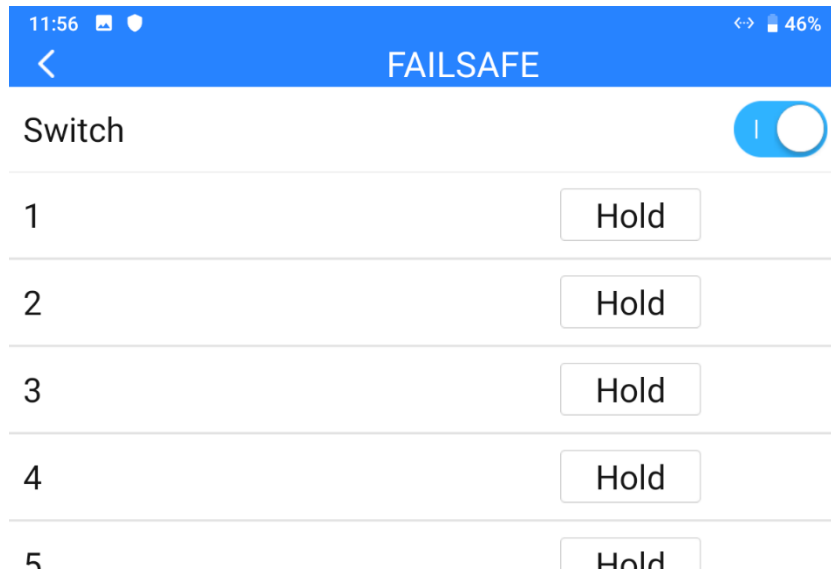

3. Failsafe function is not activated in default. The numbers on left represent channels. Channels display “Hold” when no channel value was input.

4. If you require a specific value in the channel, please turn on Failsafe switch first and switch from the “Hold” button to “Custom”. Then input your required channel value for Failsafe.

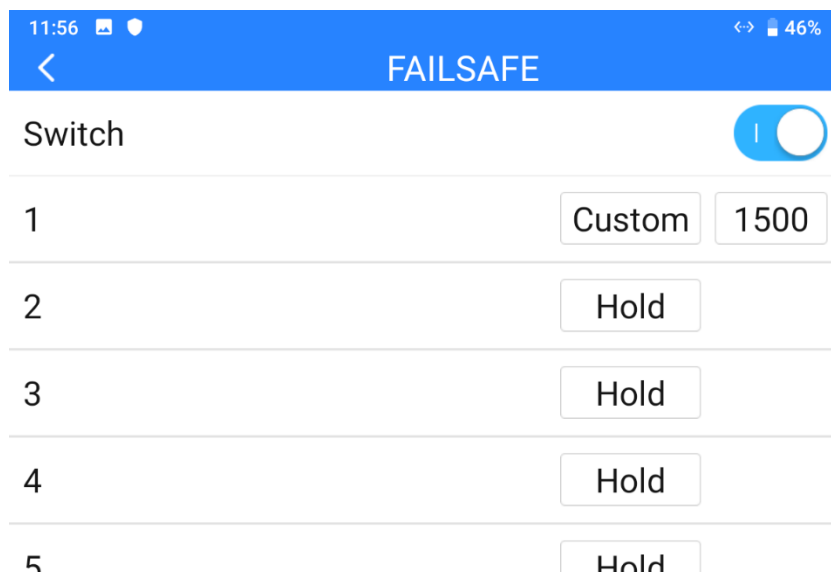

5. After configuration, the channel would output the value if the air unit lost communication with the ground unit during flight.

 **Mark**

If your flight controller communicates with the air unit through S.Bus protocol, then it is unnecessary to configure your system with Failsafe function (unless it is specially required by flight controller to activate Failsafe function and switch to RTH, by holding a specific value in a channel). You just configure your GCS with protection measures, because there are Out-of-Control marks in S.Bus protocol which tells the flight controller what situations belong to Out-of-Control.



### 3.6 Buttons / Dials

Remote controller supports changing the way that the buttons and the dials work.

#### 3.6.1 Buttons

The function changes the way that the four buttons (A, B, C, D) on MK15 transmitter works.

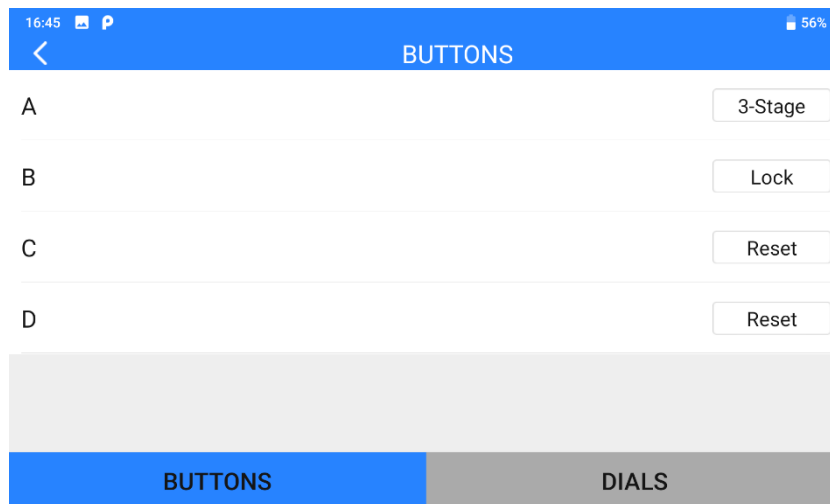

#### About Buttons

**Lock:** After pressing, the button bounces back but the channel will keep outputting 1950.

Press the button again to reset channel output to 1050.

**Reset:** Press and hold the button, the channel will output 1950. Release the button, channel output resets to 1050.

**3-Stage:** After pressing, the button will bounce back but the channel will keep outputting 1950. Press and hold the button for two seconds, the channel will output 1500. Press the button again to reset channel output to 1050.

## Mark

Press and hold the button on MK15 remote controller, which means the channel outputs 1050, LED under the button will light on. If the button is under “Lock” status, the LED will be on still until the next pressing. If the button is under “3-Stage” status and is in middle position, the LED will blink.

### 3.6.2 Dials

The function changes the way that the two dials (LD, RD) work.

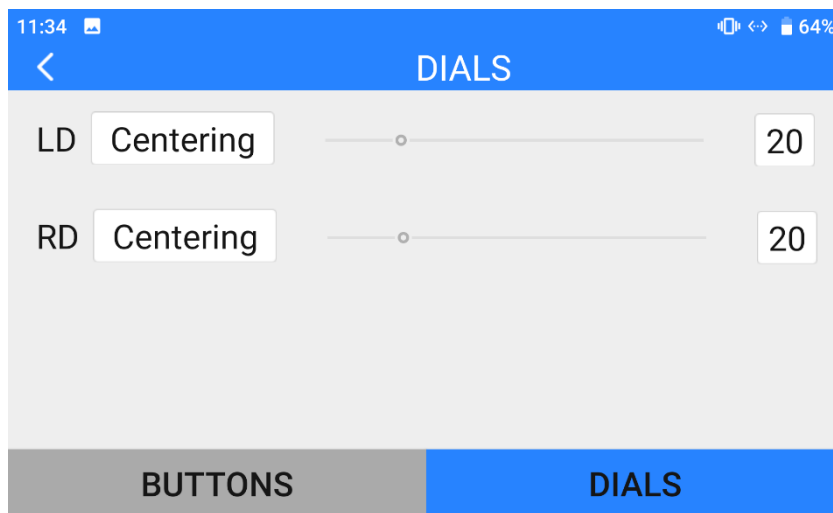

#### About Dials

Centering: Under “Centering” mode, when you push the dial and release, the dial’s outputting value will return to the initial value (middle point of the channel).

Thumb-slide: Under “Thumb-slide” mode, when you push the dial and release, the dial’s outputting value will stay at the current value.

### 3.7 Joystick Calibration

Joystick calibration function help users calibrate both joysticks' middle positions and maximum / minimum positions. Regular calibration helps maintain the control accuracy of the joysticks.

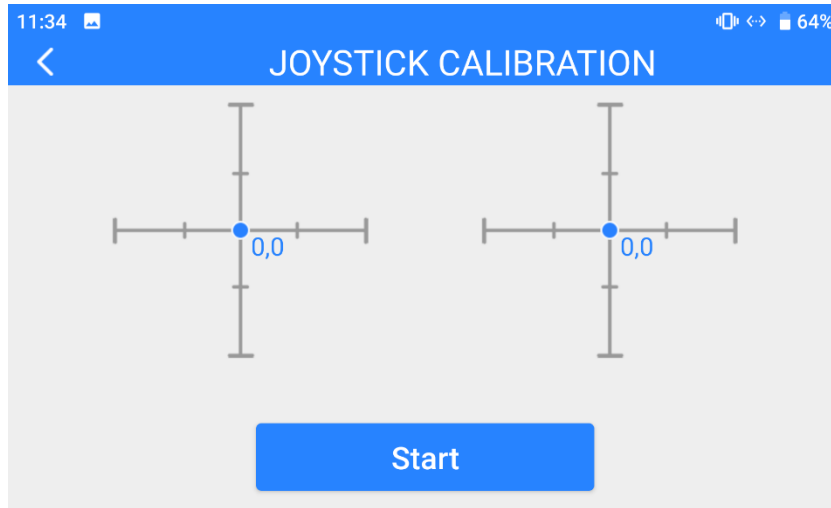

#### Steps

1. Before calibrating the joysticks, please make sure that both joysticks are naturally standstill, not displaced by any force.
2. In "Joystick Calibration" page, touch "Start", the page shows as below.

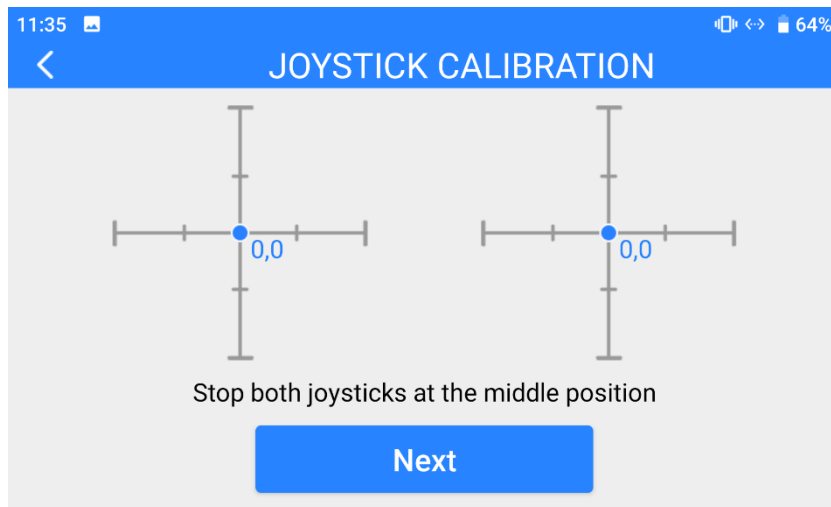

3. According to the tips, if joystick coordinates are not “(0, 0)” when both joysticks are standstill, it shows that joystick middle points are displaced. Please touch “next” and do not touch joysticks.

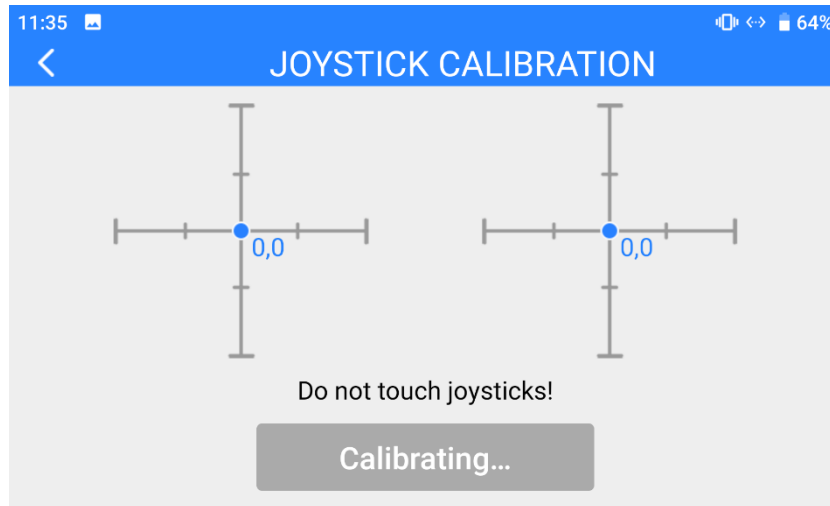

4. Calibration of joystick middle points are finished. The next step is to calibrate joystick maximum and minimum positions. Please follow the tips again to push each joystick to its maximum/minimum positions on all four dimensions.

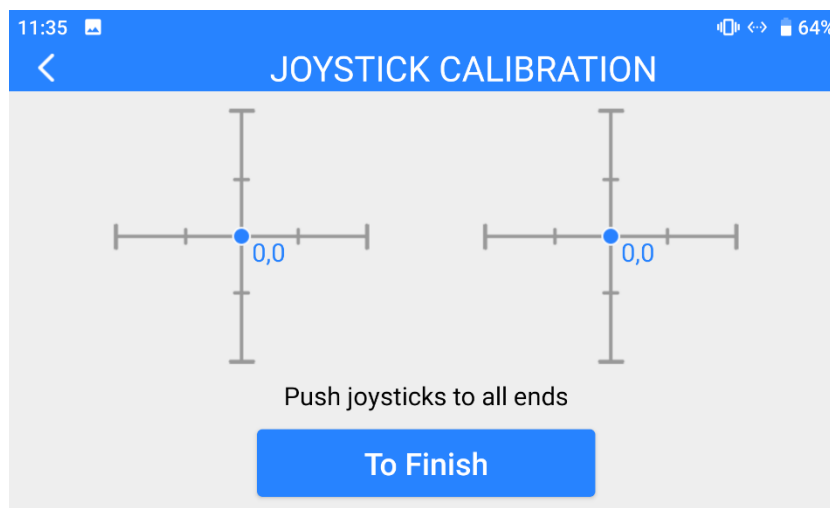

*Up: 0, 100*

*Down: 0, -100*

*Left: -100, 0*

*Right: 100, 0*

Then touch “Finish”.

5. The Joystick Calibration page will turn to its initial page. Joystick calibration is finished.

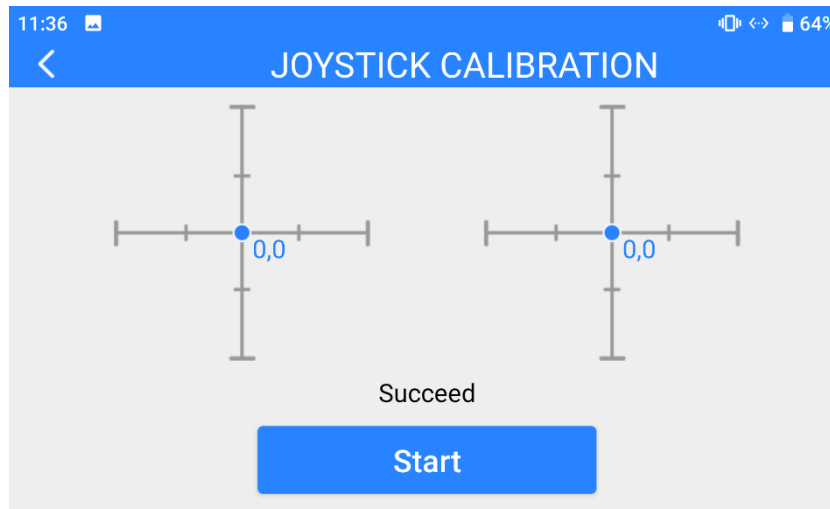

### Mark

If the joysticks do not stay in middle (coordinates are not (0, 0)) or do not output maximum/minimum value (-100 or 100), you shall calibrate them immediately.

### 3.8 Dial Calibration

Dial calibration function help users calibrate both dials' middle positions and maximum/minimum positions. Regular calibration helps maintain control accuracy of the dials.

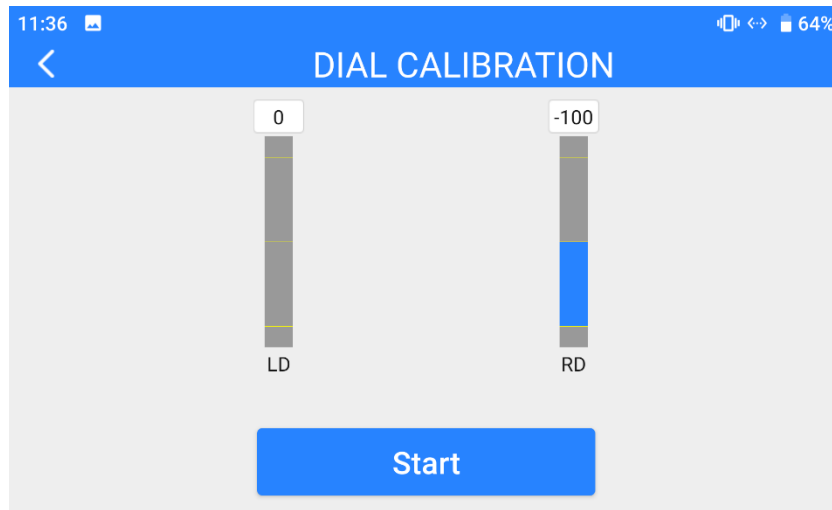

#### Steps

1. Before calibrating the dials, please make sure that both dials are naturally standstill, not displaced by any force.
2. In "Dial Calibration" page, touch "Start", the page shows as below.

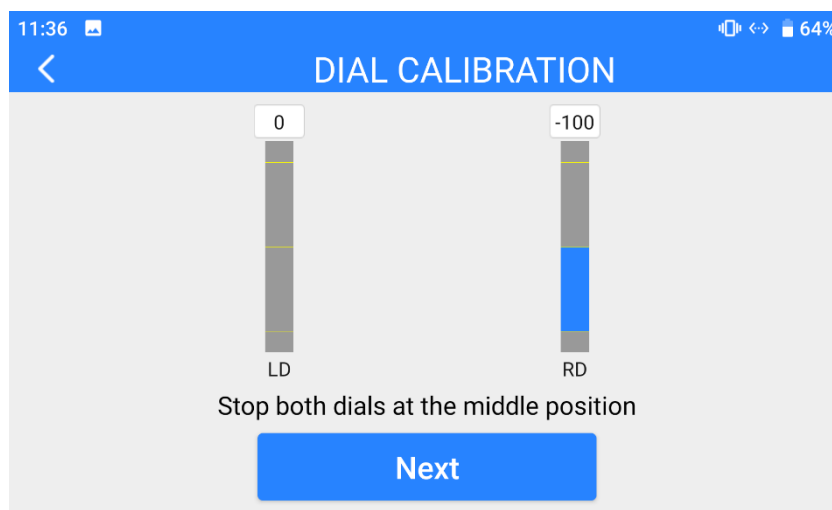

3. According to the tips, if dials' coordinates are not "(0, 0)" when both dials are standstill, it means that dial middle points are displaced. Please touch "next" and do not touch the dials.

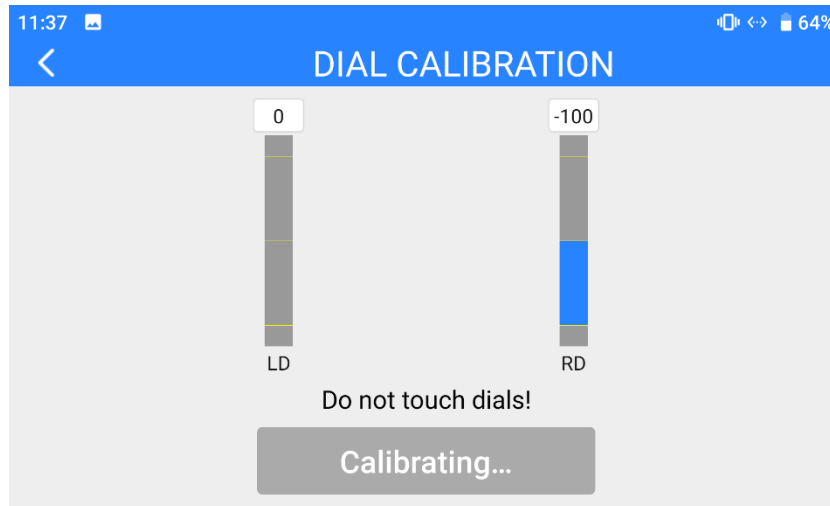

4. Calibration of dial middle points is finished. The next step is to calibrate dial maximum and minimum positions.

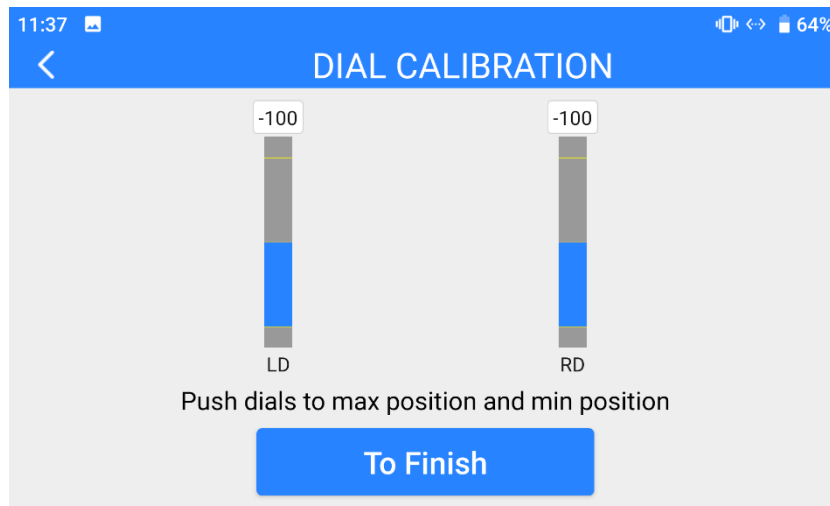

Please follow the tips again and push each dial to its maximum and minimum position.

Then touch "Finish".

5. Dial Calibration page will return to its initial page. Dial calibration is finished.

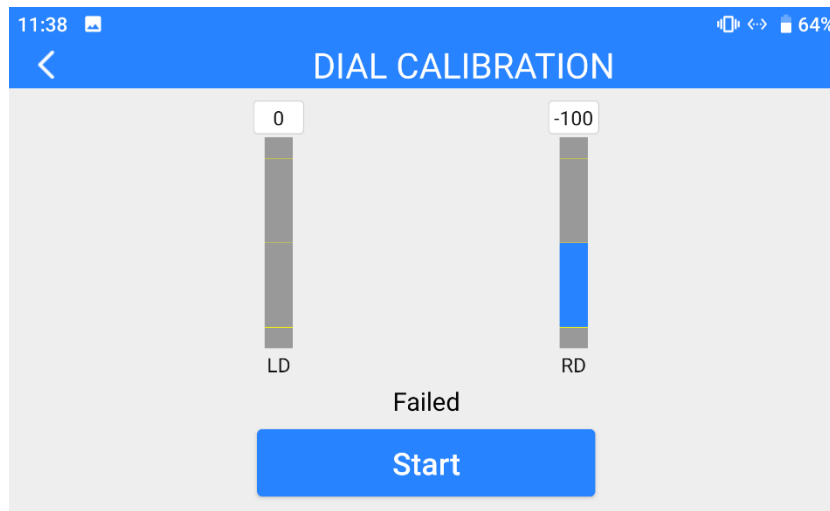

**Mark**

If the dials do not stay in middle (coordinates are not 0) or do not output maximum / minimum value (-100 or 100), you shall calibrate them immediately.



### 3.9 Multiple Links

The Multiple Links feature only comes with the dual edition, which includes details of its two main function “Remote Control Relay” and “Dual Operator”.



#### About Multiple Links

**Function Type:** Switch the function between “Remote Control Relay” and “Dual Operator” and switching between “TX-A” and “TX-B” at the same time.

**Bind:** Bind “TX-A” and “TX-B” with the air unit in turns after configuring function type.

**Control Switch:** Define a button or a switch to take over control in “Remote Control Relay” mode, or to switch control of certain channels between “TX-A” and “TX-B” in “Dual Operator” mode.

**Control Channel:** In “Dual Operator” mode, define channel mapping for TX-A and assign channels to TX-B according to your requirement.

### 3.9.1 Remote Control Relay

The "remote-control relay" function is developed for ultra-long-distance flight missions. It supports two ground units to relay control the same air unit to reach a maximum transmission distance twice that of a single standard transmission system.

#### Steps

1. Prepare two MK15 remote controllers (dual edition).
2. Go to "Multiple Links – Function Type", assign the two remote controllers as "RC Relay TX-A" and "RC Relay TX-B".

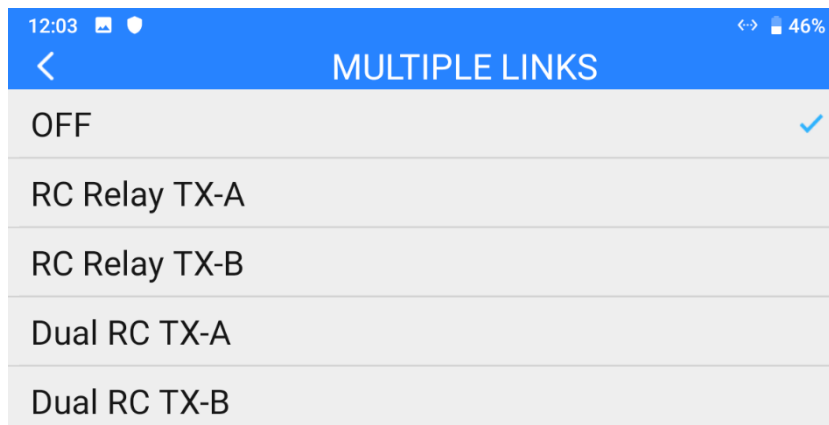

3. Bind "TX-A" and "TX-B" to the same air unit in turns.
4. In "Control Switch" page, assign a switch / button / dial to switch control of the air unit from "TX-A" to "TX-B".

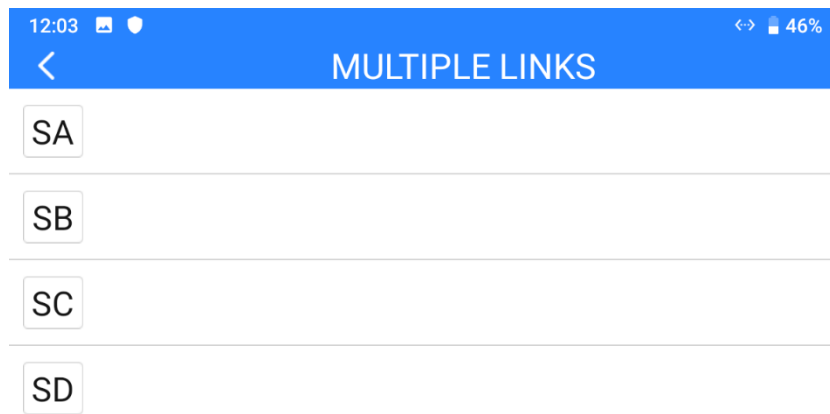

5. RC Relay settings are finished.

### 3.9.2 Dual Operator

The "dual operator" function is developed for dual-operator scenarios and supports up to two ground units to establish links with the same air unit at the same time. One can be used to control the flight attitude of the drone, and the other can be used to control the gimbal camera, optical pod, and other payloads.

#### Steps

1. Prepare two MK15 remote controllers (dual edition).
2. Go to "Multiple Links – Function Type", assign the two ground units as "Dual RC TX-A" and "Dual RC TX-B".

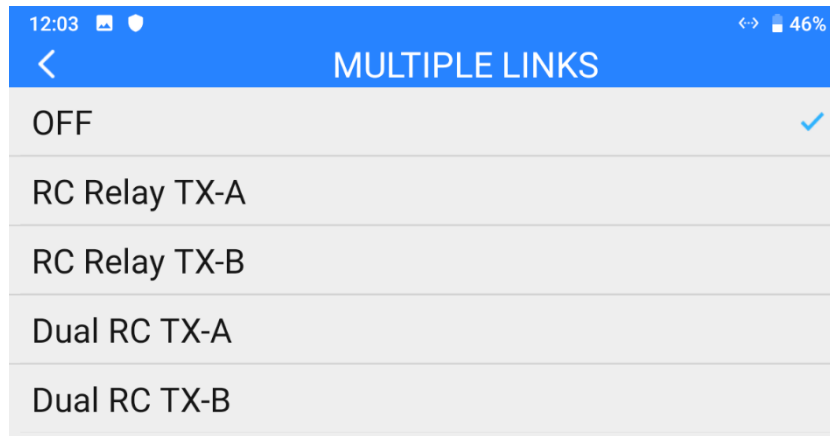

3. Bind “TX-A” and “TX-B” with the same air unit in turns.
4. In “Control Switch” page, assign a switch / button / dial to switch control to the air unit from “TX-A” to “TX-B”.

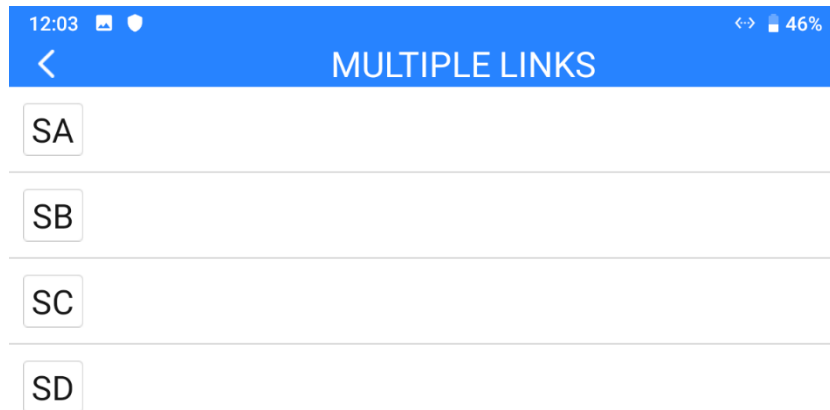

5. In “Control Channels” page, configure channel mappings for “TX-A”, then assign the decided channels to “TX-B”. Thus, when the Dual RC function is enabled, “TX-A” can authorize to “TX-B” or withdraw from “TX-B” the control of the assigned channels.

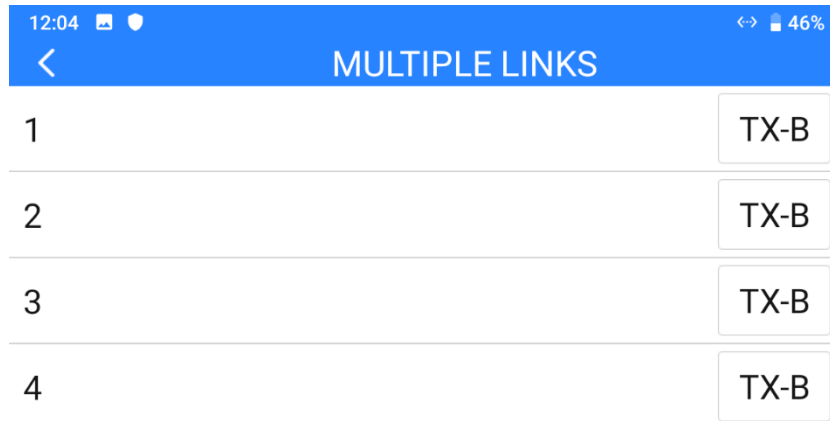

6. Dual RC settings are finished.

### Mark

The “Dual Operator” function works similarly to “Wireless Coach” function. Thus, the dual editions can also be used for drone training and education.

### DANGER

When the “Dual Operator” function is enabled and “TX-A” lost control to the air unit, “TX-B” will lose control to the air unit, either.

### 3.10 Device Info

Displays the major factory information of the system.

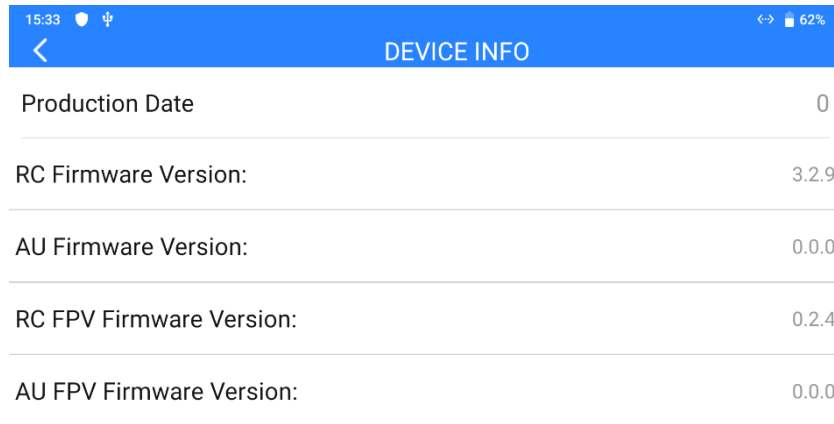

DEVICE INFO	
Production Date	0
RC Firmware Version:	3.2.9
AU Firmware Version:	0.0.0
RC FPV Firmware Version:	0.2.4
AU FPV Firmware Version:	0.0.0

#### About Device Info

**Production Date:** Displays the manufacturing date of the system.

**RC Firmware Version:** Displays the function firmware version of the remote controller.

**AU Firmware Version:** Displays the function firmware version of the air unit.

**RC FPV Firmware Version:** Displays the FPV firmware version of the remote controller.

**AU FPV Firmware Version:** Displays the FPV firmware version of the air unit.

#### **Mark**

The remote controller and air unit FPV firmware are not open for customer upgrade.

### 3.11 SIYI TX App Update Log

<b>Date</b>	2023-07-18
<b>Version</b>	1.1.240
<b>Updates</b>	1. New (MK32): Support remote controller signal output.

<b>Date</b>	2023-07-11
<b>Version</b>	1.1.239
<b>Updates</b>	<ol style="list-style-type: none"> <li>1. Improve: Frequency self-adapting support searching for the best channel.</li> <li>2. Fix: System settings do not display setting status.</li> <li>3. New: Support manually switching frequency channel.</li> </ol>

## 4 DATALINK

Datalink is one of the core features in most SIYI links.

MK15 remote controller supports communication with different ground control software through various hardware interface.

### 4.1 Communication with Android GCS through UART

#### 4.1.1 JIYI Agri-Assistant

1. In “SIYI TX” app, go to “Datalink”, and choose “UART” in “Connection”, “JIYI (K3A / K++)” in “Flight Controller”, and “57600” in “Baud Rate”.

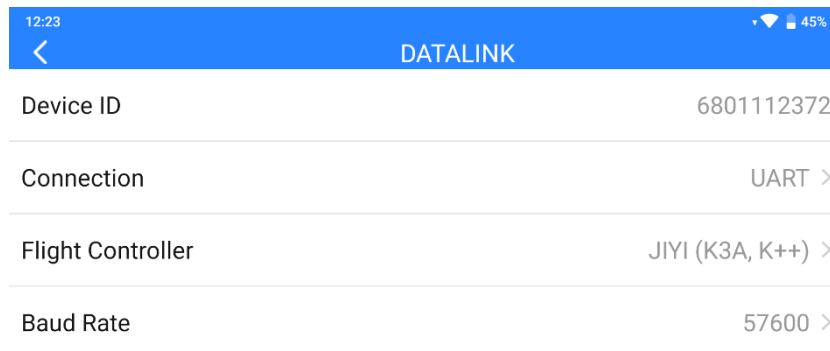

2. Run JIYI Agri-Assistant, choose “MK15” as the connection method.

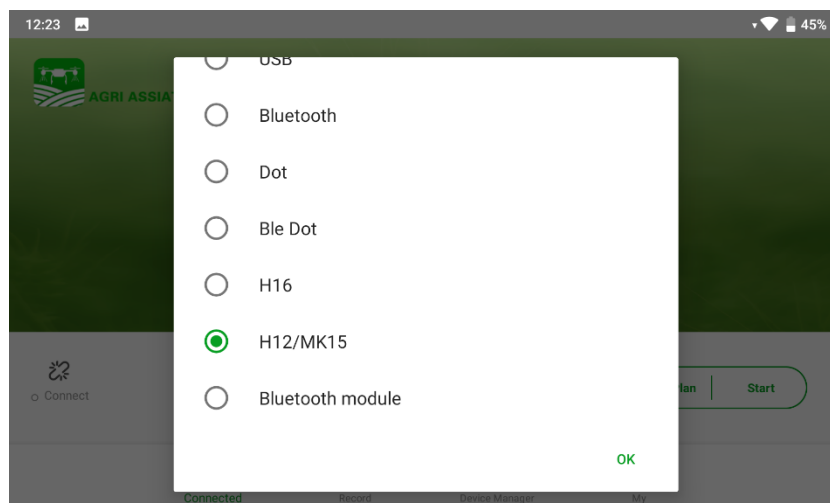



3. After confirming, remote controller will communicate with JIYI app automatically and shows “device connected”. Datalink connection is established.

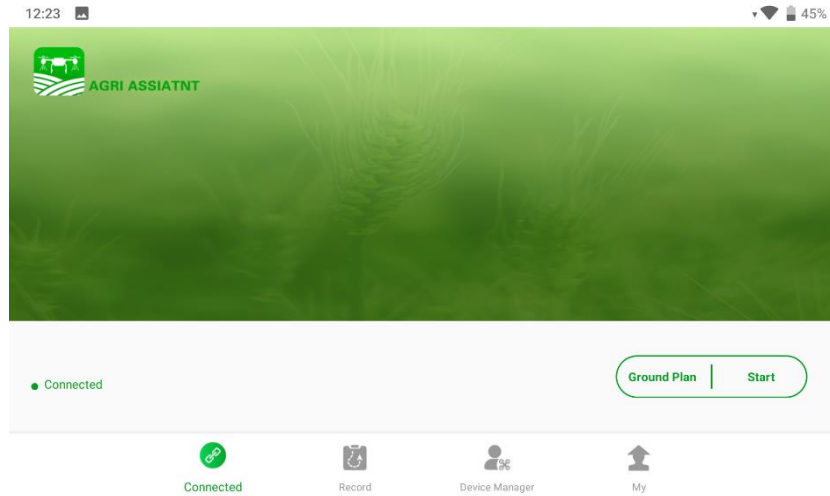

## Mark

SIYI links also support datalink connection to JIYI Agri-Assistant through Bluetooth.

### 4.1.2 BOYING Agriculture

1. In “SIYI TX” app, go to “Datalink”, and choose “UART” in “Connection”, “BOYING (Paladin)” in “Flight Controller”, and “57600” in “Baud Rate”.

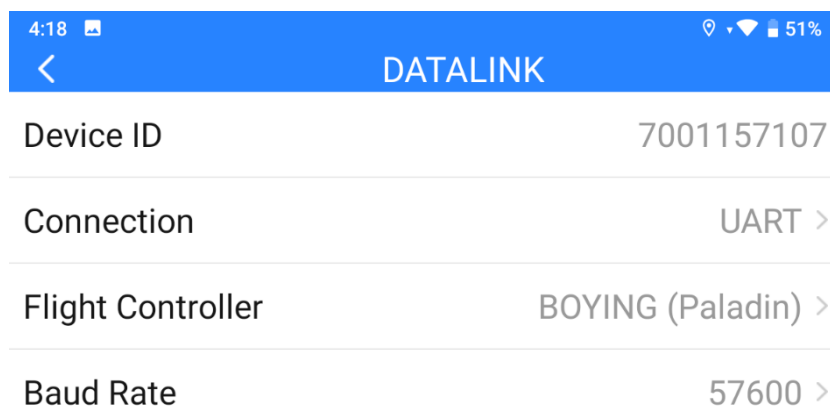

2. Run BOYING agriculture, choose “MK15” as the connection method.

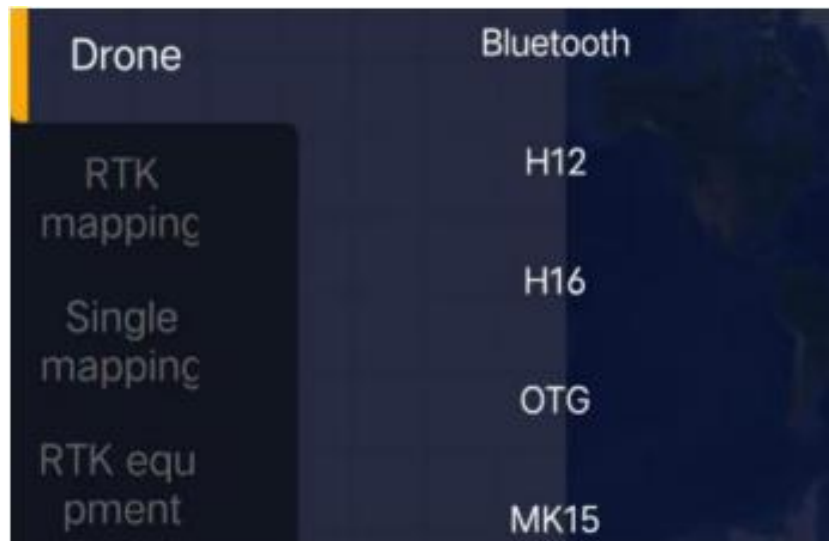

3. After confirming, remote controller will communicate with the BOYING app automatically and shows “device connected”. Datalink connection is established.

**Mark**

SIYI links also support datalink connection to BOYING GCS through Bluetooth.

**4.1.3 VK Agriculture**

1. In “SIYI TX” app, go to “Datalink”, and choose “UART” in “Connection”, “VK (V7AG / V9AG)” in “Flight Controller”. The baud rate will automatically adapt to “115200”.

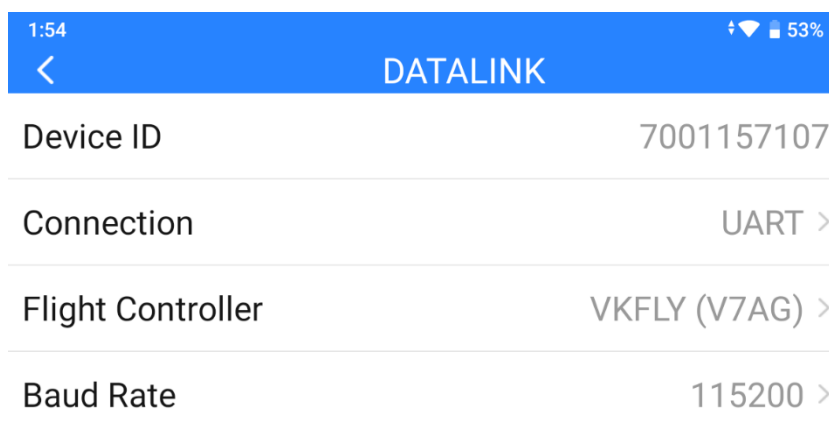

2. Run VK GCS, remote controller will communicate with the VK app automatically and shows “device connected”. Datalink connection is established.

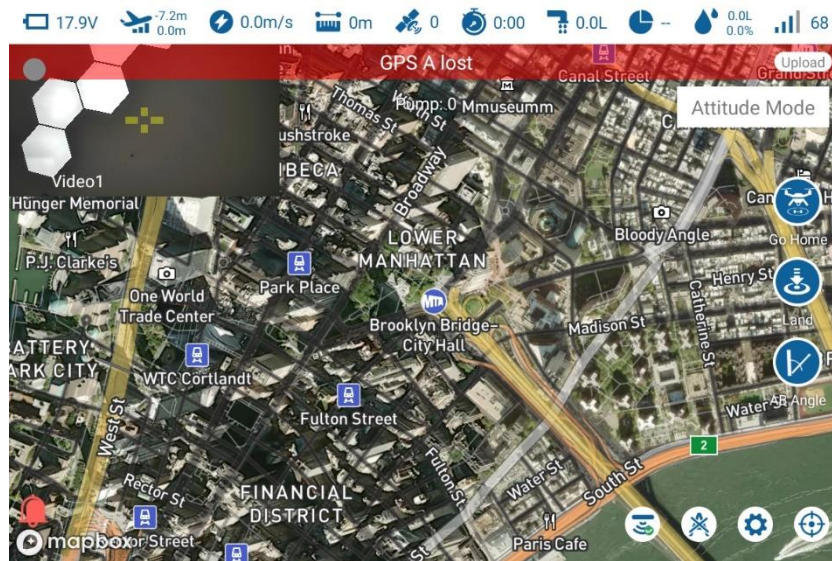

**Mark**

SIYI links also support datalink connection to BOYING GCS through Bluetooth.

## 4.2 Communication with Android GCS through USB COM

### 4.2.1 QGroundControl

1. In “SIYI TX” app, go to “Datalink”, and choose “USB COM” in “Connection”, “PIX / PX4 / Ardupilot” in “Flight Controller”, and match the baud rate with the flight controller TELEM port’s.

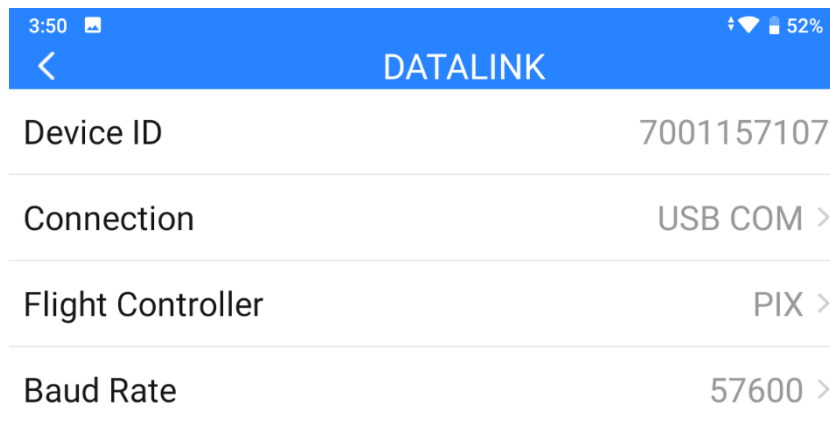

2. Run QGroundControl, go to “Application Settings – Comm Links” and “Add” a new connection. Name it as “USB-COM”. Connection “Type” as “Serial”. Match the baud rate.

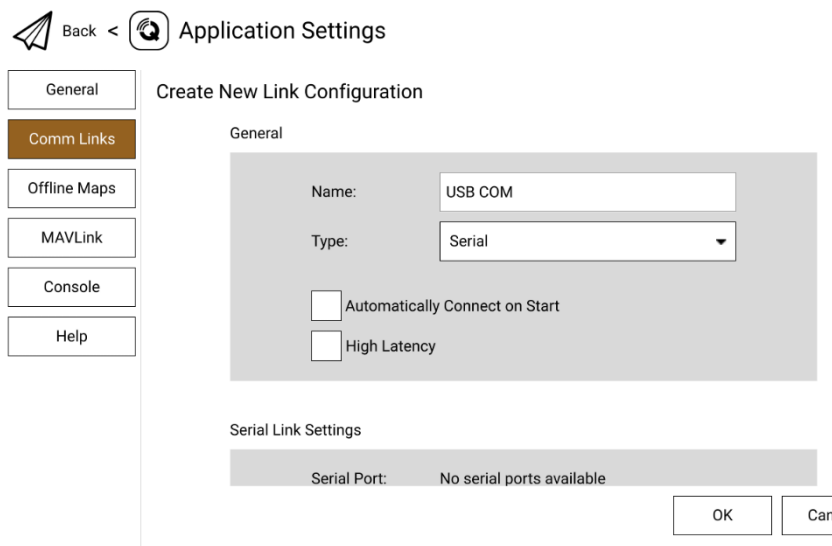

3. Confirm and start to “Connect”. The top progress bar in QGC starts to move, which means the remote controller is communicate with QGC automatically. Please wait until the datalink connection is established.

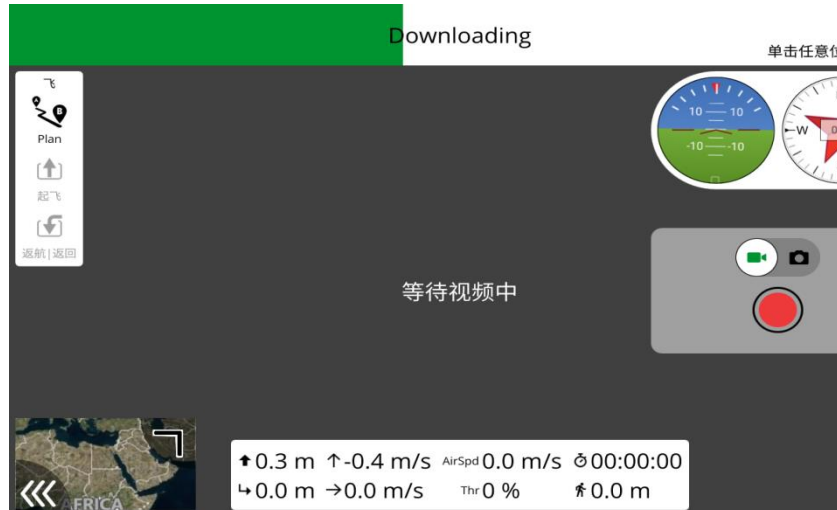

## Mark

If it is your first time adding a new connection in QGC, please do not check the option “Automatically Connect on Start”. It can be checked later when you confirm that the datalink is connected successfully.

### 4.2.2 Mission Planner

1. In “SIYI TX” app, go to “Datalink”, and choose “USB COM” in “Connection”, “PIX / PX4 / Ardupilot” in “Flight Controller”, and match the baud rate with the flight controller TELEM port’s.

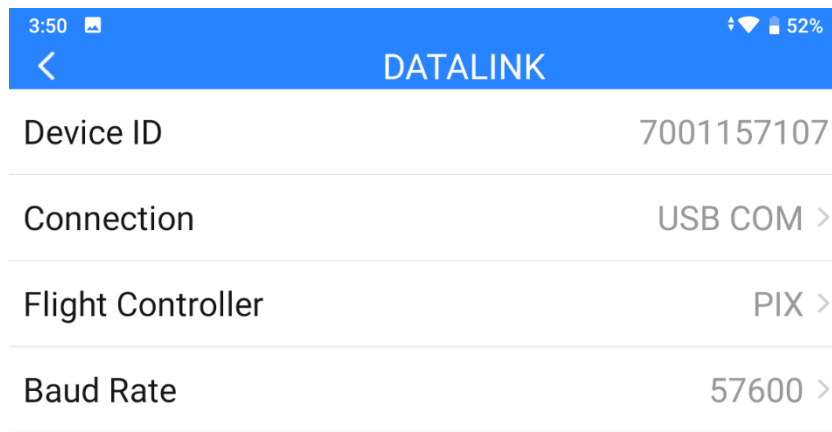

2. Run Mission Planner, select the relevant port and match the baud rate.



3. Please wait until the datalink connection is established.



## 4.3 Communication with Android GCS via Bluetooth

### 4.3.1 QGroundControl

1. In “SIYI TX” app, go to “Datalink”, and choose “Bluetooth” in “Connection”, “PIX / PX4 / Ardupilot” in “Flight Controller”, and match the baud rate with the flight controller TELEM port’s.

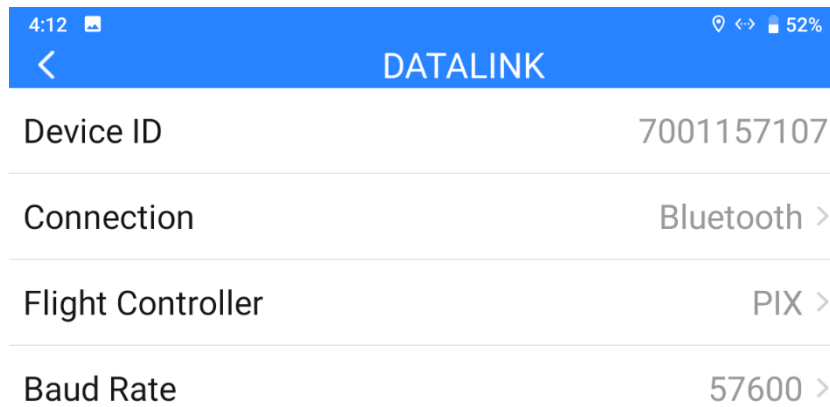

2. In Android OS, go to “System Settings - Bluetooth”, search the Bluetooth device with the same ID shown in “Device ID” (“SIYI 68\*\*\*\*\*”), and pair.
3. Run QGroundControl, go to “Application Settings - Comm Links” page, and “Add” a new connection. Name it as “Bluetooth”.

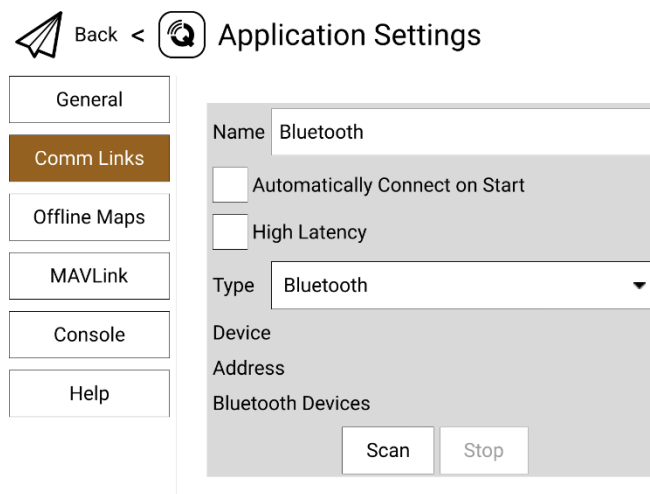

4. Set the type as “Bluetooth”, then touch “Scan”.

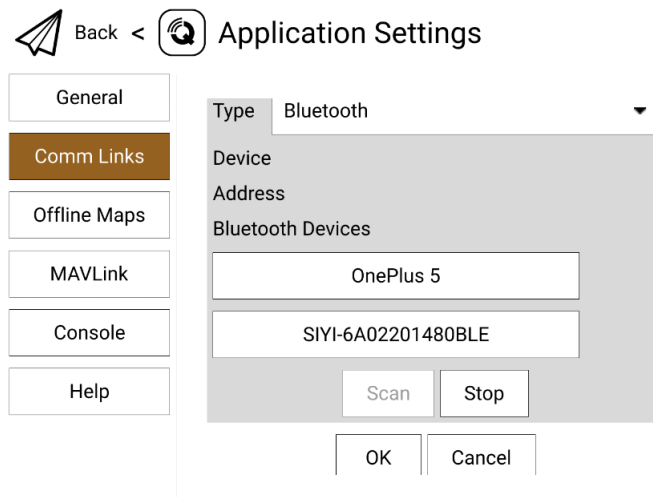

5. Touch the Bluetooth device of which the name is starting with “SIYI-XXXXXXX”, then touch “OK” to go back to the Comm Links page.

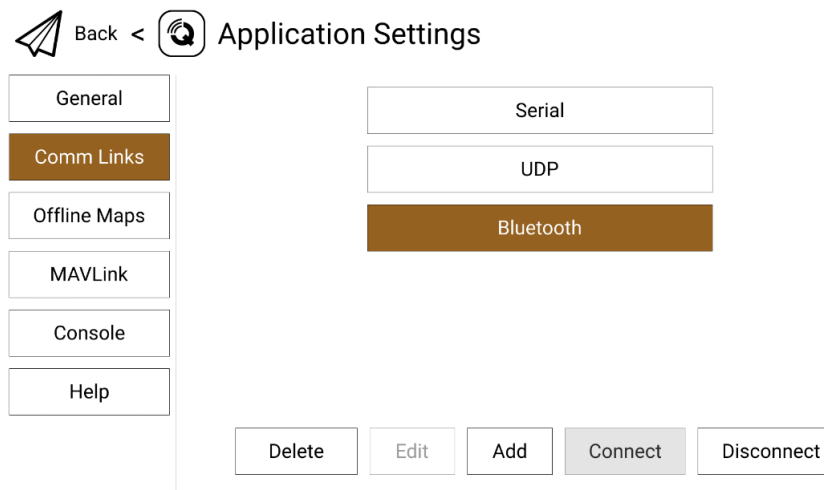

4. Confirm and start to “Connect”. The top progress bar in QGC starts to move, which means the remote controller is communicate with QGC automatically. Please wait until the datalink connection is established.



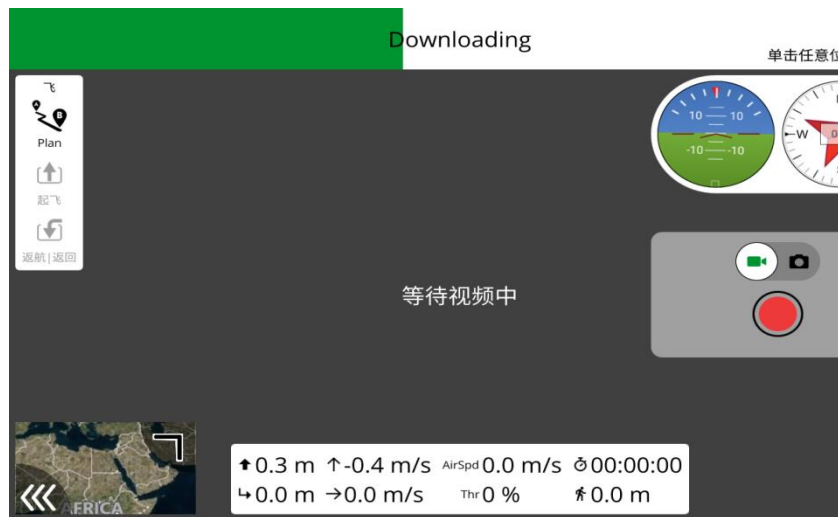

## ● Mark

Step 1 and 2 have been finished before delivery.

If it is your first time adding a new connection in QGC, please do not check the option “Automatically Connect on Start”. It can be checked later when you confirm that the datalink is connected successfully.

### 4.3.2 Mission Planner

1. In “SIYI TX” app, go to “Datalink”, and choose “Bluetooth” in “Connection”, “PIX / PX4 / Ardupilot” in “Flight Controller”, and match the baud rate with the flight controller TELEM port’s.

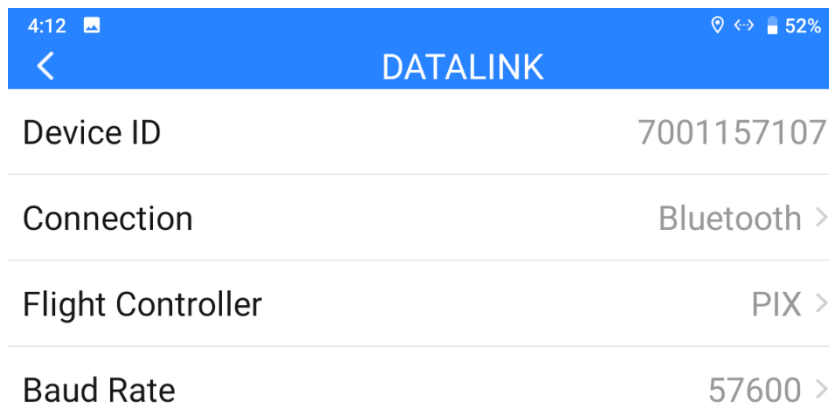

2. Run Mission Planner, select the relevant port (COM-xx Bluetooth) and match the baud rate.



3. Please wait until the datalink connection is established.



## 4.4 Communication with Android GCS through UDP

### 4.4.1 QGroundControl

1. In “SIYI TX” app, go to “Datalink”, and choose “UDP” in “Connection”, “PIX / PX4 / Ardupilot” in “Flight Controller”, and match the baud rate with the flight controller TELEM port’s.

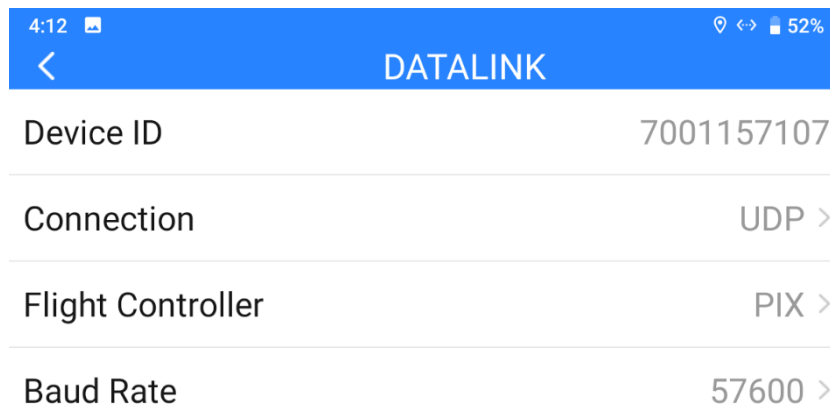

2. Run QGroundControl, go to “Application Settings - Comm Links” page, and “Add” a new connection. Name it as “UDP”.

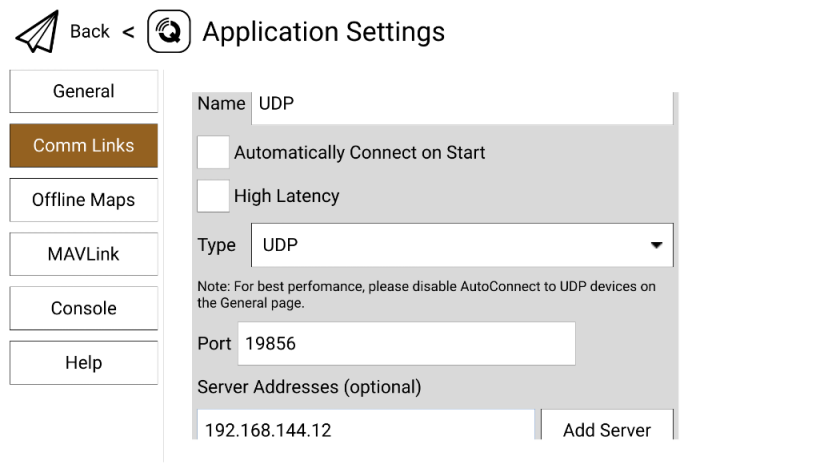

3. Set the connection “Type” as “UDP”, “Port” as “19856”, “Server Addresses” as “192.168.144.12” and “Add Server”.

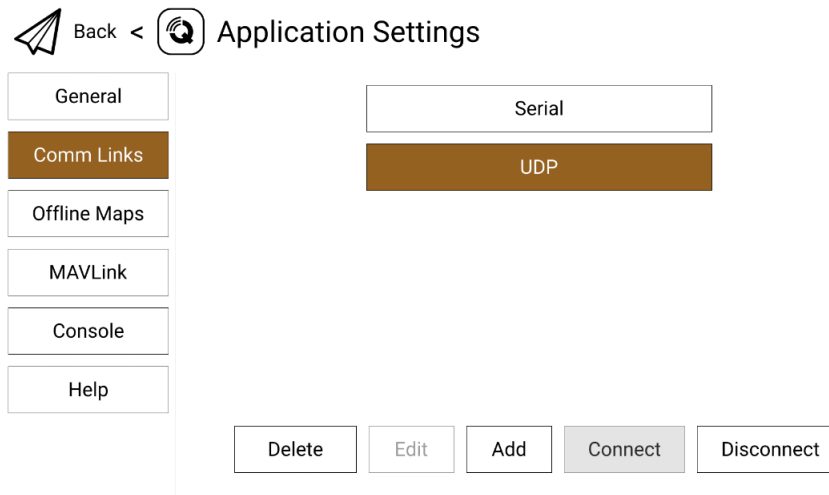

4. Confirm and start to “Connect”. The top progress bar in QGC starts to move, which means the remote controller is communicate with QGC automatically. Please wait until the datalink connection is established.

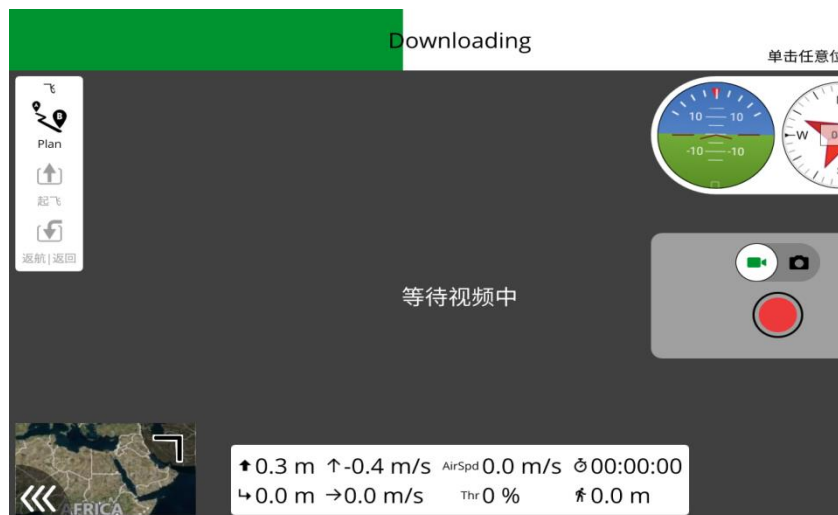

**Mark**

If it is your first time adding a new connection in QGC, please do not check the option “Automatically Connect on Start”. It can be checked later when you confirm that the datalink is connected successfully.

### 4.4.2 Mission Planner

1. In “SIYI TX” app, go to “Datalink”, and choose “UDP” in “Connection”, “PIX / PX4 / Ardupilot” in “Flight Controller”, and match the baud rate with the flight controller TELEM port’s.

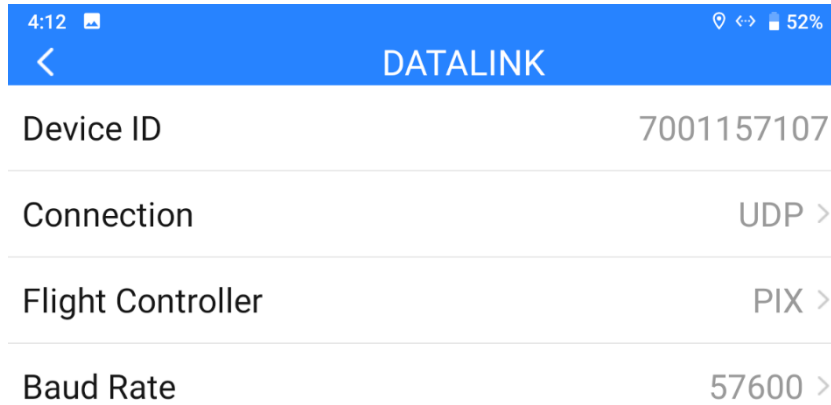

2. Run Mission Planner, select the relevant port (UDPCI) and match the baud rate. “Port” as “19856”. “Server addresses” as “192.168.144.12”. Then connect.



### 3. Please wait until the datalink connection is established.



### Mark

To use UDP datalink connection in Mission Planner, the remote controller FPV firmware should be v0.2.4 and above.

## 4.5 Communication with Windows GCS through Upgrade Port

### 4.5.1 QGroundControl

1. Connect the remote controller's upgrade port to the Windows computer, the Windows system will generate a communication port for the remote controller.
2. In "SIYI TX" app, go to "Datalink", and choose "Upgrade Port (MK15) / Type-C (MK32)" in "Connection", "PIX / PX4 / Ardupilot" in "Flight Controller", and match the baud rate with the flight controller TELEM port's.

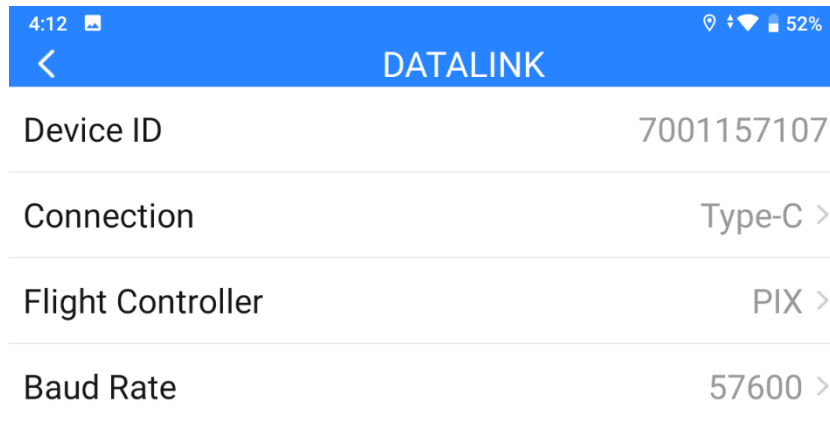

3. Run QGroundControl, go to "Application Settings – Comm Links" and "Add" a new connection. Name it as "USB-COM". Connection "Type" as "Serial". Match the baud rate.

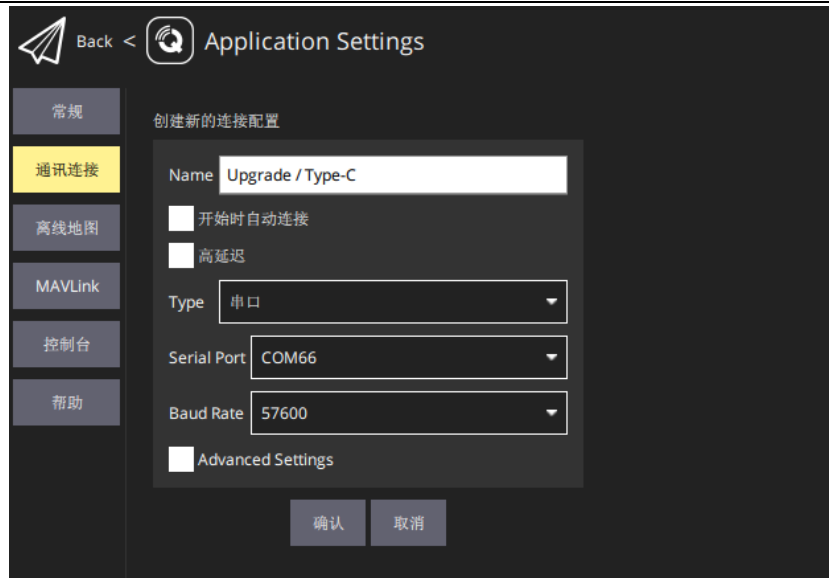

4. Confirm and start to “Connect”. The top progress bar in QGC starts to move, which means the remote controller is communicate with QGC automatically. Please wait until the datalink connection is established.

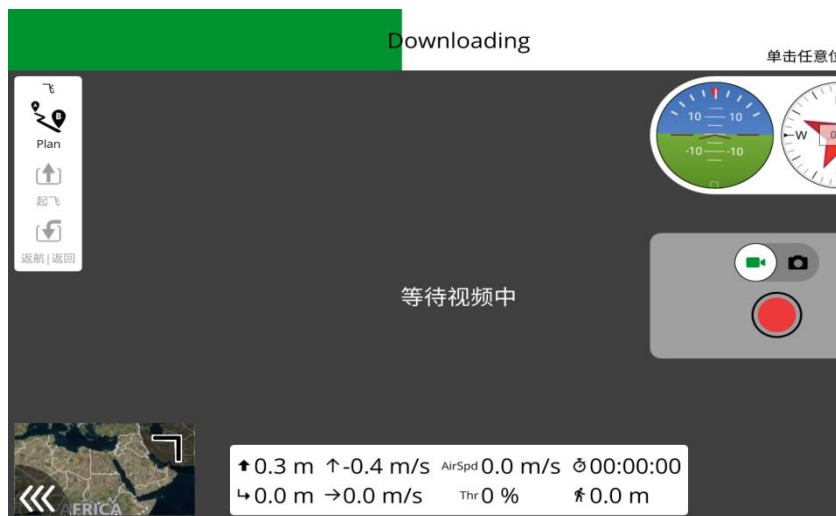

**Mark**

If it is your first time adding a new connection in QGC, please do not check the option “Automatically Connect on Start”. It can be checked later when you confirm that the datalink is connected successfully.



### 4.5.2 Mission Planner

1. Connect the remote controller’s upgrade port to the Windows computer, the Windows system will generate a communication port for the remote controller.
2. In “SIYI TX” app, go to “Datalink”, and choose “Upgrade Port (MK15) / Type-C (MK32)” in “Connection”, “PIX / PX4 / Ardupilot” in “Flight Controller”, and match the baud rate with the flight controller TELEM port’s.

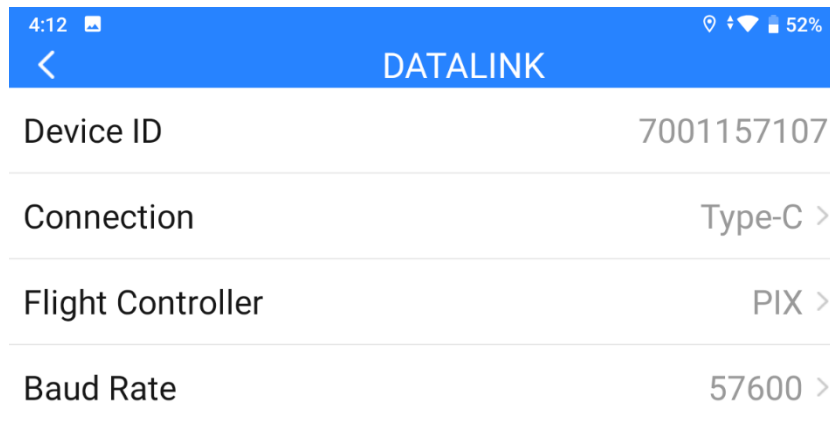

3. Run Mission Planner, select the relevant port and match the baud rate.



4. Please wait until the datalink connection is established.



## 4.6 Communication with Windows GCS by UDP through Remote Controller WiFi Hotspot

### 4.6.1 QGroundControl

1. In “SIYI TX” app, go to “Datalink”, and choose “UDP” in “Connection”, “PIX / PX4 / Ardupilot” in “Flight Controller”, and match the baud rate with the flight controller TELEM port’s.

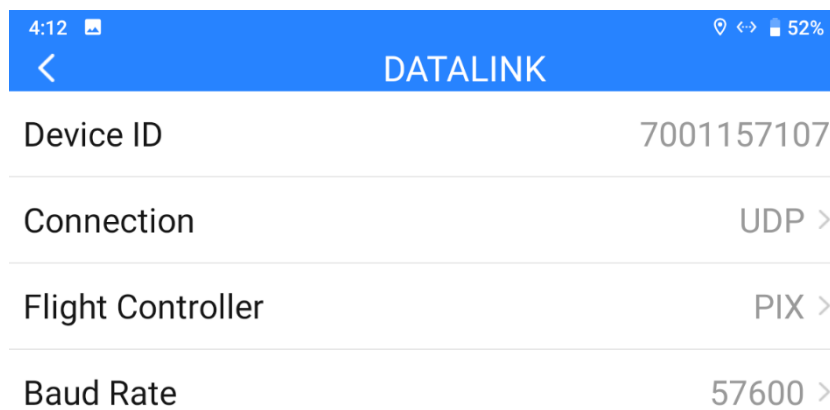

2. Enable the WiFi hotspot in remote controller Android system, connect the remote controller with the Windows computer through WiFi.
3. Run QGroundControl, go to “Application Settings - Comm Links” page, and “Add” a new connection. Name it as “UDP”.

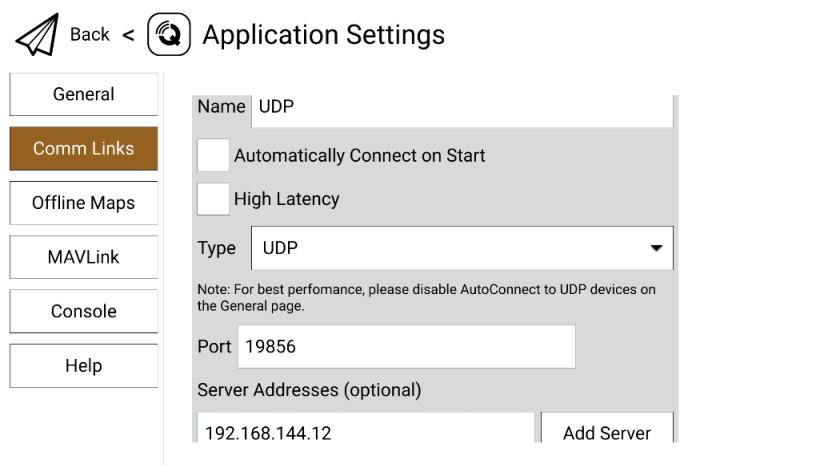

4. Set the connection “Type” as “UDP”, “Port” as “19856”, “Server Addresses” as “192.168.144.12” and “Add Server”.

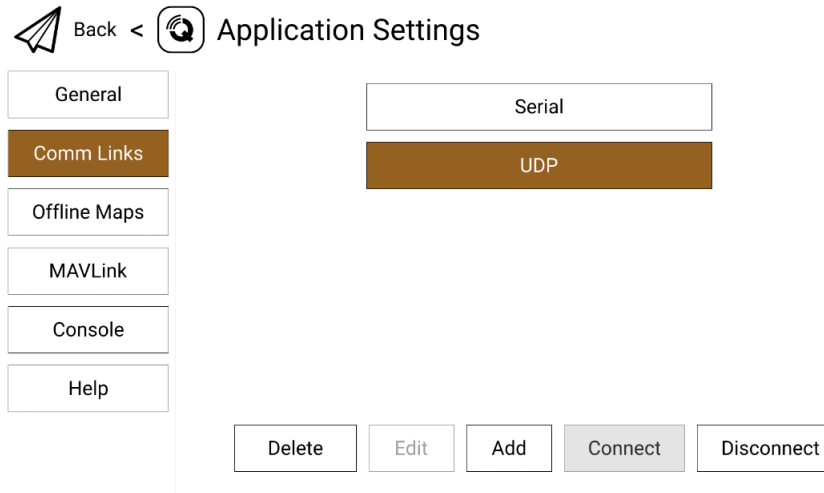

5. Confirm and start to “Connect”. The top progress bar in QGC starts to move, which means the remote controller is communicate with QGC automatically. Please wait until the datalink connection is established.

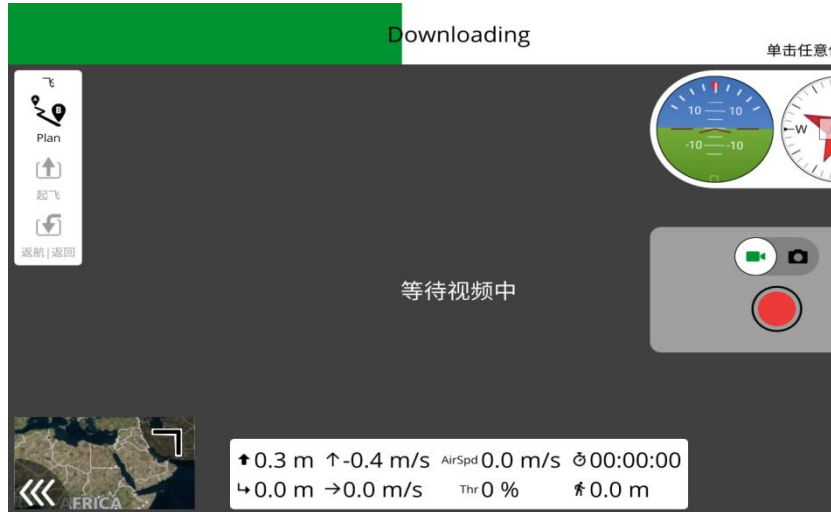

If it is your first time adding a new connection in QGC, please do not check the option “Automatically Connect on Start”. It can be checked later when you confirm that the datalink is connected successfully.

#### 4.4.2 Mission Planner

1. In “SIYI TX” app, go to “Datalink”, and choose “UDP” in “Connection”, “PIX / PX4 / Ardupilot” in “Flight Controller”, and match the baud rate with the flight controller TELEM port’s.

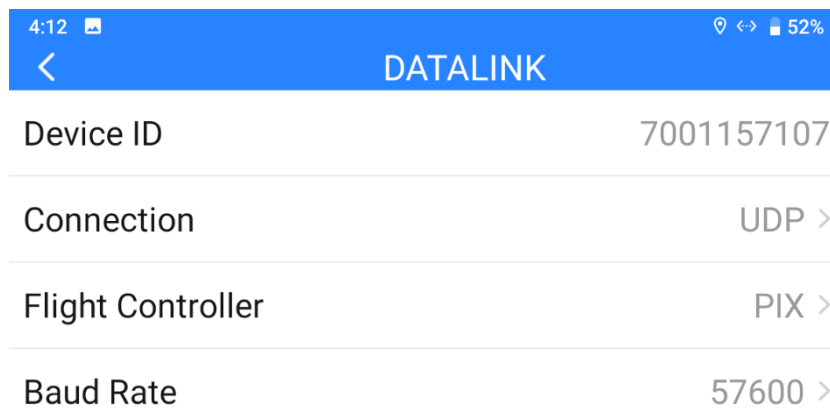

2. Enable the WiFi hotspot in remote controller Android system, connect the remote controller with the Windows computer through WiFi.
3. Run Mission Planner, select the relevant port (UDPCI) and match the baud rate. “Port” as “19856”. “Server addresses” as “192.168.144.12”. Then connect.



4. Please wait until the datalink connection is established.



**Mark**

To use UDP datalink connection in Mission Planner, the remote controller FPV firmware should be v0.2.4 and above.

## 4.7 Solutions to Disconnection

When the remote controller is in good communication with the air unit, but it fails to establish datalink connection with GCS, please try to follow the steps below for troubleshooting.

1. Confirm if the air unit is wired to the flight controller by correct telemetry cable.
2. If you are using a customized telemetry cable, please check:
  - If cable pin map is correct?
  - If the TX and RX pins in the flight controller and air unit telemetry port are swapped?
3. In “SIYI TX” app, go to the “Link Status” page to check communication status. When the communication is good, “data download” is not 0. If it is “0”, please go back to check step 1 and 2.
4. In “SIYI TX” app, go to the “Datalink” page and check:
  - If “Connection” is correctly configured?
  - If “Flight Controller” is correctly configured?
  - If “Baud Rate” matches with your flight controller?
  - In the GCS, check if the datalink settings are correctly configured.
5. If it is PX4 / Ardupilot open-source flight controller, please try to switch telemetry cable connection between the TELEM 1 port and the TELEM 2 port on flight controller.
6. If both the remote controller and air unit are the latest firmware?

 **Mark**

If you have done trouble shooting by following all steps above, but there are still no clues, please contact your reseller or SIYI after-sale service.



## 4.8 SIYI Datalink SDK

SIYI links can be integrated to customers' own network or ground station by acquiring SDK communication protocol.

### 4.8.1 Format

Field	Index	Bytes	Description
STX	0	2	0x5566: starting mark
CTRL	2	1	0: need_ack (if the current package need "ack") 1: ack_pack (if the package is an "ack" package) 2-7: Reserved
Data_len	3	2	Data field byte length. <b>Low byte in the front.</b>
SEQ	5	2	Frame sequence (0~65535) . <b>Low byte in the front.</b>
CMD_ID	7	1	Command ID
DATA	8	Data_len	Data
CRC16		2	CRC16 check to the complete data package. <b>Low byte in the front.</b>

### 4.8.2 Commands

#### Request Remote Controller Hardware ID

CMD_ID:0x40 ----- Request Remote Controller Hardware ID			
Send data format			
No.	Data Type	Data Name	Data Description
ACK data format			
	UInt8_t	hardware_id[12]	Hard ID String (10 digits)

Example:

Send (HEX): 55 66 01 00 00 00 00 40 81 9c

Response (HEX): 55 66 02 0C 00 09 00 40 36 38 30 31 31 33 30 31 31 31 00 00 7b 8b

#### Request Remote Controller System Settings

CMD_ID:0x16 ----- Request Remote Controller System Settings			
Send data format (10 Hz)			
No.	Data Type	Data Name	Data Description
ACK data format			
	UInt8_t	match	Bind: 0: Start 1, 2: Binding 3: Finished
	UInt8_t	Baud_type	Telemetry Baud Rate: 0: BAUD_4800 1: BAUD_9600 2: BAUD_38400 3: BAUD_57600 4: BAUD_76800 5: BAUD_115200 6: BAUD_230400
	UInt8_t	Joy_type	Joystick Type: 0: Mode 1 1: Mode 2 2: Mode 3 3: Custom
	UInt8_t	Rc_bat	Ground Unit Battery Level x 10V

### Send System Settings Commands to Remote Controller

CMD_ID:0x17 ----- Send System Settings Commands to Remote Controller			
Send data format			
No.	Data Type	Data Name	Data Description
	UInt8_t	match	Bind: 0: Start 1, 2: Binding 3: Finished
	UInt8_t	Baud_type	Telemetry Baud Rate: 0: BAUD_4800 1: BAUD_9600 2: BAUD_38400 3: BAUD_57600 4: BAUD_76800 5: BAUD_115200 6: BAUD_230400
	UInt8_t	Joy_type	Joystick Type: 0: Mode 1 1: Mode 2

			2: Mode 3 3: Custom
	UInt8_t	reserved	
ACK Data Format			
	int8_t	sta	1: ok Negative number means error

## Request Remote Control Channels

CMD_ID:0x42 ----- Request Remote Control Channel Data			
Send data format			
No.	Data Type	Data Name	Data Description
	UInt8_t	freq	Output Frequency 0: OFF 1: 2Hz 2: 4Hz 3: 5Hz 4: 10Hz 5: 20Hz 6: 50Hz 7: 100Hz
ACK data format			
1	int16_t	CH1	Two bytes in each channel (default 1050~1950)
2	int16_t	CH2	
3	int16_t	CH3	
.....	int16_t	.....	
16	int16_t	CH16	

Mark:

Enabling RC channel output will affect telemetry communication as they are using the same port.

Example:

Send (HEX):

55 66 01 01 00 00 00 42 02 B5 C0 (4 Hz)

55 66 01 01 00 00 00 42 00 F7 E0 (OFF)

Response (HEX) (2 Hz):

55 66 00 20 00 99 00 42 DC 05 DC 00 DC 05 DC 05 DC 05 DC 05 DC 05 DC 05 DC 05 DC 05 DC 05 DC 05 DC 05 1A 04

DC 05 DC 05 1A 04 1A 04 FF 88

## Request Remote Controller Link Status

CMD_ID:0x43 ----- Request Remote Controller Link Status			
Send data format			
No.	Data Type	Data Name	Data Description
ACK data format			
	uint16_t	freq	Frequency
	uint8_t	pack_loss_rate	Loss Rate
	uint16_t	real_pack	Valid Package
	uint16_t	real_pack_rate	Valid Package Rate
	uint32_t	data_up	Data upload byte/s
	uint32_t	data_down	Data download byte/s

Example:

Send (HEX): 55 66 01 00 00 00 00 43 e2 ac

Response (HEX): 55 66 02 0F 00 01 00 43 02 00 00 02 00 02 00 00 00 00 00 00 00 00 00 00 2E 5C

## Request FPV Link Status

CMD_ID:0x44 ----- Request FPV Link Status			
Send data format			
No.	Data Type	Data Name	Data Description
ACK Data Format			
	int32_t	signal	Signal percentage: %
	int32_t	inactive_time	--
	int32_t	upstream	Data upload: byte/s
	int32_t	downstream	Data download: byte/s
	int32_t	txbandwidth	Upload bandwidth (txbandwidth / 1000 Mbps)
	int32_t	rxbandwidth	Download bandwidth (rxbandwidth / 1000 Mbps)
	int32_t	rss	RF power: dBm
	int32_t	freq	Current frequency: Mhz
	int32_t	channel	Current Channel

Example:

Send (HEX): 55 66 01 00 00 00 00 44 05 dc

Response (HEX): 55 66 02 24 00 02 00 44 00 A4 15 00 00 6C 00 00 00 2C D9

## Request Firmware Version

CMD_ID:0x47 ----- Request Firmware Version			
Send data format			
No.	Data Type	Data Name	Data Description
ACK Data Format			
	uint32_t	rc_version	Remote controller function firmware version
	uint32_t	rf_version	Air unit function firmware version
	uint32_t	ground_version	Remote controller FPV firmware version
	uint32_t	sky_version	Air unit FPV firmware version

Mark:

The request firmware version is four bytes in hexadecimal, with the first byte in the low bit and the last byte in the high bit. The first byte is the product ID, and the remaining three bytes are the version number.

For example, 0x00 0x03 0x05 0x68, the product ID is 0x68, and the version number is 5.3.0. The same applies to other version numbers.

Example:

Send (HEX): 55 66 01 00 00 00 00 47 66 ec

Response (HEX): 55 66 02 10 00 02 00 47 00 03 05 68 07 02 05 69 02 02 00 56 02 02 00 56 6d 21

### 4.8.3 Communication Interface

SIYI datalink SDK supports four interfaces, which can be switched in SIYI TX app.

#### 1) UART Serial Port

Port Name: /dev/ttyHS0

Baud Rate: 115200

#### 2) USB COM (USB to Serial) (Baud rate is the same with datalink baud rate)

### 3) Bluetooth

### 4) MK15 RC Upgrade Port / MK32 RC Type-C Port (Virtual serial port based on USB port)

#### 4.8.4 SDK CRC16 Check Code

```
const uint16_t crc16_tab[256];
```

```

/*****
CRC16 Coding & Decoding G(X) = X^16+X^12+X^5+1
*****/
uint16_t CRC16_cal(uint8_t *ptr, uint32_t len, uint16_t crc_init)
{
    uint16_t crc,   oldcrc16;
    uint8_t  temp;
    crc = crc_init;
    while (len--!=0)
    {
        temp=(crc>>8)&0xff;
        oldcrc16=crc16_tab[*ptr^temp];
        crc=(crc<<8)^oldcrc16;
        ptr++;
    }
    //crc=~crc;    //??
    return(crc);
}

```

```

uint8_t crc_check_16bites(uint8_t* pbuf, uint32_t len, uint32_t* p_result)
{
    uint16_t crc_result = 0;
    crc_result= CRC16_cal(pbuf, len, 0);
    *p_result = crc_result;

    return 2;
}

```

```

const uint16_t crc16_tab[256]= {0x0,0x1021,0x2042,0x3063,0x4084,0x50a5,0x60c6,0x70e7,
                                0x8108,0x9129,0xa14a,0xb16b,0xc18c,0xd1ad,0xe1ce,0xf1ef,

```

```
0x1231,0x210,0x3273,0x2252,0x52b5,0x4294,0x72f7,0x62d6,  
0x9339,0x8318,0xb37b,0xa35a,0xd3bd,0xc39c,0xf3ff,0xe3de,  
0x2462,0x3443,0x420,0x1401,0x64e6,0x74c7,0x44a4,0x5485,  
0xa56a,0xb54b,0x8528,0x9509,0xe5ee,0xf5cf,0xc5ac,0xd58d,  
0x3653,0x2672,0x1611,0x630,0x76d7,0x66f6,0x5695,0x46b4,  
0xb75b,0xa77a,0x9719,0x8738,0xf7df,0xe7fe,0xd79d,0xc7bc,  
0x48c4,0x58e5,0x6886,0x78a7,0x840,0x1861,0x2802,0x3823,  
0xc9cc,0xd9ed,0xe98e,0xf9af,0x8948,0x9969,0xa90a,0xb92b,  
0x5af5,0x4ad4,0x7ab7,0x6a96,0x1a71,0xa50,0x3a33,0x2a12,  
0xdbfd,0xcdbc,0xfbbf,0xeb9e,0x9b79,0x8b58,0xbb3b,0xab1a,  
0x6ca6,0x7c87,0x4ce4,0x5cc5,0x2c22,0x3c03,0xc60,0x1c41,  
0xeda6,0xfd8f,0xcdec,0xddcd,0xad2a,0xbd0b,0x8d68,0x9d49,  
0x7e97,0x6eb6,0x5ed5,0x4ef4,0x3e13,0x2e32,0x1e51,0xe70,  
0xff9f,0xefbe,0xdfdd,0xcffc,0xbf1b,0xaf3a,0x9f59,0x8f78,  
0x9188,0x81a9,0xb1ca,0xa1eb,0xd10c,0xc12d,0xf14e,0xe16f,  
0x1080,0xa1,0x30c2,0x20e3,0x5004,0x4025,0x7046,0x6067,  
0x83b9,0x9398,0xa3fb,0xb3da,0xc33d,0xd31c,0xe37f,0xf35e,  
0x2b1,0x1290,0x22f3,0x32d2,0x4235,0x5214,0x6277,0x7256,  
0xb5ea,0xa5cb,0x95a8,0x8589,0xf56e,0xe54f,0xd52c,0xc50d,  
0x34e2,0x24c3,0x14a0,0x481,0x7466,0x6447,0x5424,0x4405,  
0xa7db,0xb7fa,0x8799,0x97b8,0xe75f,0xf77e,0xc71d,0xd73c,  
0x26d3,0x36f2,0x691,0x16b0,0x6657,0x7676,0x4615,0x5634,  
0xd94c,0xc96d,0xf90e,0xe92f,0x99c8,0x89e9,0xb98a,0xa9ab,  
0x5844,0x4865,0x7806,0x6827,0x18c0,0x8e1,0x3882,0x28a3,  
0xcb7d,0xdb5c,0xeb3f,0xfb1e,0x8bf9,0x9bd8,0xabbb,0xbb9a,  
0x4a75,0x5a54,0x6a37,0x7a16,0xaf1,0x1ad0,0x2ab3,0x3a92,  
0xfd2e,0xed0f,0xdd6c,0xcd4d,0xbdaa,0xad8b,0x9de8,0x8dc9,  
0x7c26,0x6c07,0x5c64,0x4c45,0x3ca2,0x2c83,0x1ce0,0xcc1,  
0xef1f,0xff3e,0xcf5d,0xdf7c,0xaf9b,0xbfba,0x8fd9,0x9ff8,  
0x6e17,0x7e36,0x4e55,0x5e74,0x2e93,0x3eb2,0xed1,0x1ef0  
};
```

## 5 SIYI FPV APP

SIYI FPV is an Android application developed by SIYI to configure many SIYI products for video display, camera stream settings, and communication link status monitoring.

### **Mark**

This chapter is edited based on SIYI FPV App v2.5.15.660.

SIYI FPV App can be downloaded from SIYI official website:

<https://siyi.biz/en/index.php?id=downloads&asd=427>

#### **SIYI FPV App compatible SIYI devices**

- ZT30 Four-Sensor Optical Pod
- ZR30 4K AI 180X Hybrid Zoom Optical Pod
- A2 mini Ultra-Wide-Angle FPV Gimbal
- MK32 / MK32E Enterprise Handheld Ground Station
- A8 mini AI Zoom Gimbal Camera
- ZR10 2K 30X Hybrid Zoom Optical Pod
- R1M HD Recording FPV Camera
- Air Unit HDMI Input Converter
- HM30 Full HD Image Transmission System
- MK15 / MK15E Mini Handheld Ground Station



## SIYI FPV App OSD Information Definition

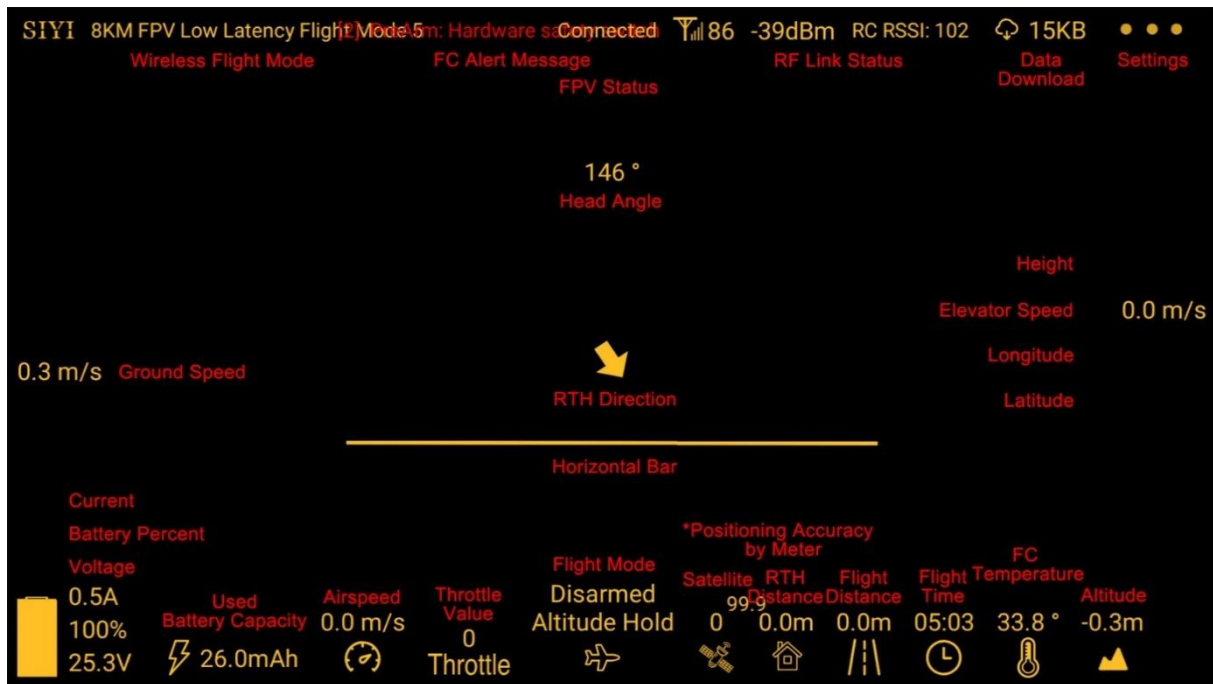

## SIYI FPV Camera Function Icon Definition



## 5.1 Settings

In “Settings” page, you can select camera type with stream type, select or input video stream IP addresses, custom app interface, and switch video decoding type.

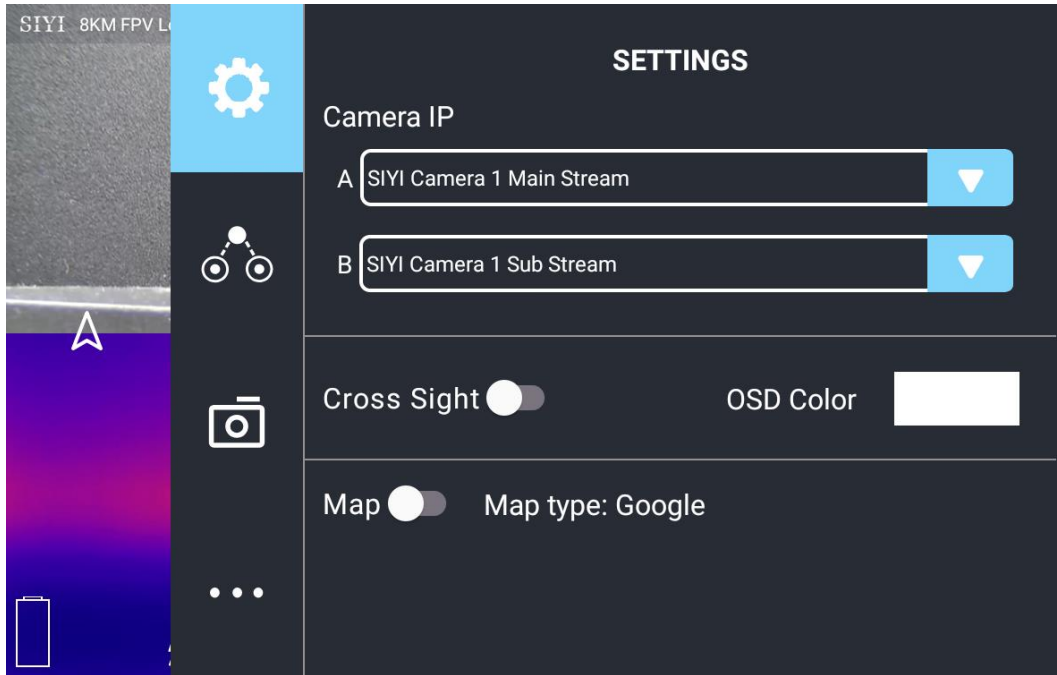

### About Settings

**Camera IP:** Select between SIYI Camera 1 and SIYI Camera 2, between main stream and sub stream, select or input video stream RTSP addresses, disable image, or rotate the relevant image in 180 degrees.

**Cross Sight:** Enable / disable a cross sight in the center of the image.

**Map:** Enable / disable the map box over the left-bottom corner of the image.

**OSD Color:** Custom the color of all OSD information.

**Decoding Type:** Switch between “Hardware Decoding” and “Software Decoding”. Please refer to your camera and your device to display video for the best decoding type.

## 5.2 Link Status

Display the link status directly over the FPV image.

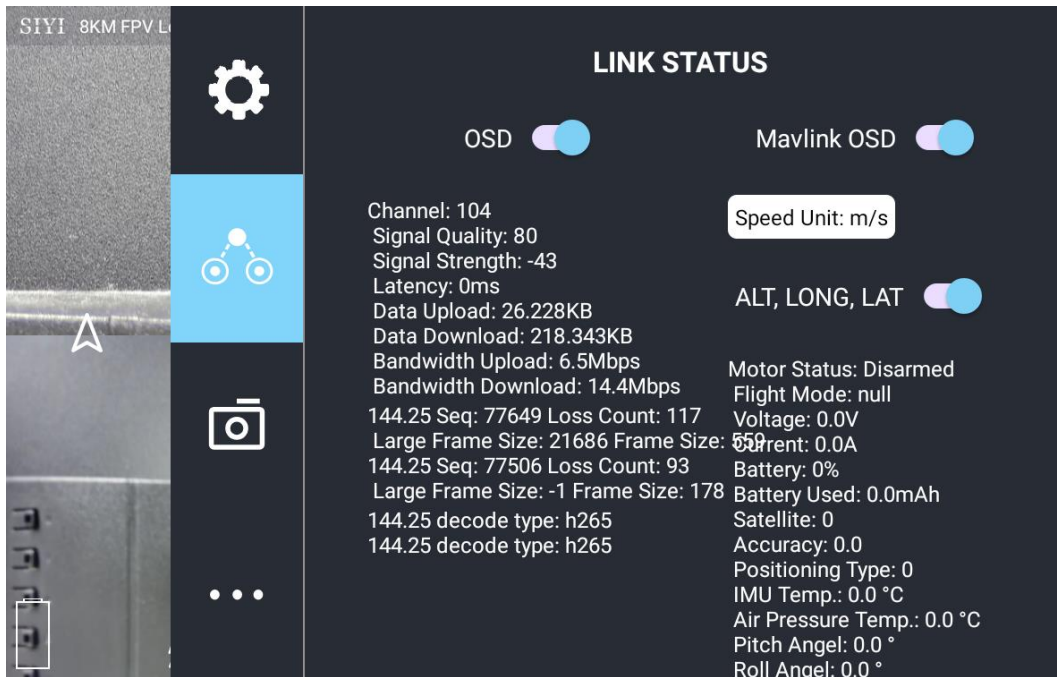

### About Link Status

**OSD:** Enable / disable standard OSD information.

**Mavlink OSD:** Enable / disable Mavlink OSD information.

**Speed Unit:** Switch speed unit between meter per seconds and kilometer per hour.

**Longitude and Latitude:** Enable / disable information.

### 5.3 Gimbal Camera

Configure the abundant functions of SIYI optical pod and gimbal camera.

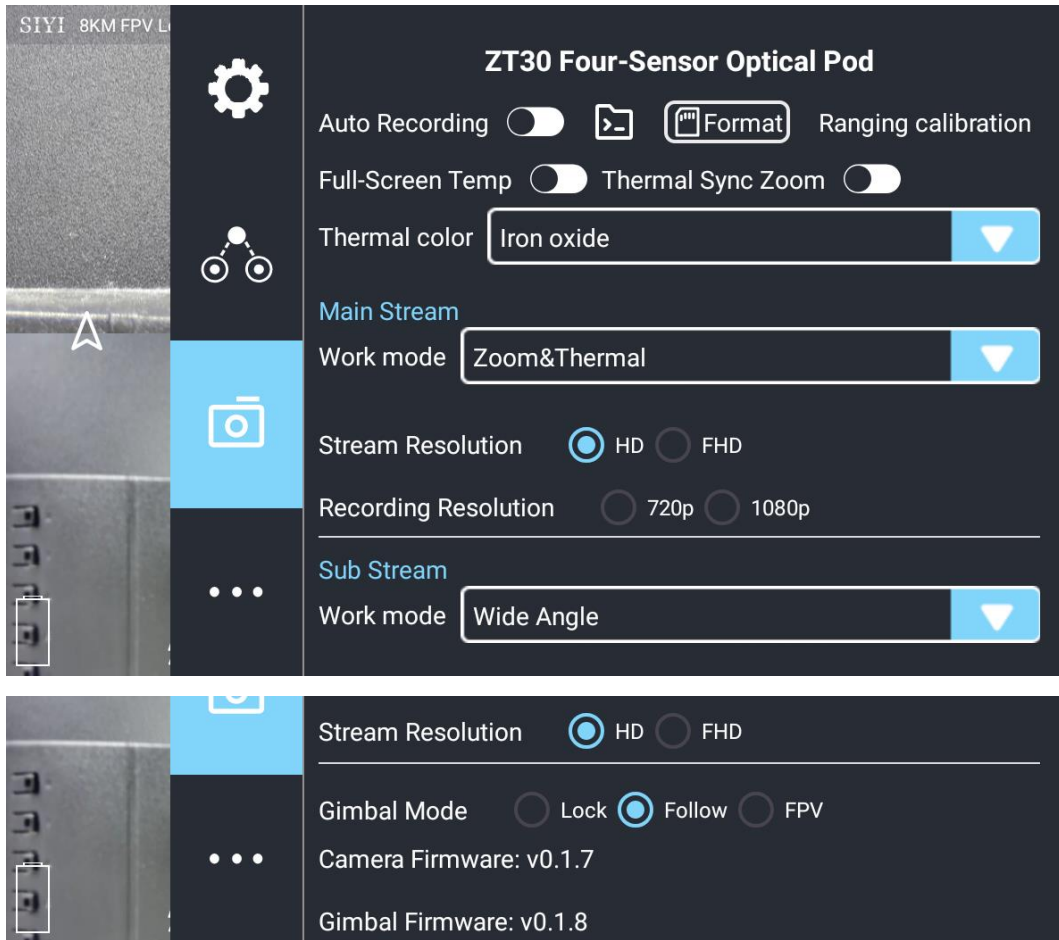

#### About Gimbal Camera

**Boot Record:** Enable / disable automatic video recording by SD card as soon as gimbal camera is powered.

**File Manager:** Preview stored images in TF card. Format the TF card.

**Laser Calibration:** The target position in the camera image may need to be calibrated to match the accurate laser rangefinder orientation.

**Full Image Thermometric:** Enable / disable the full image temperature measurement feature in the thermal imaging camera.

**Synchronize Zoom:** Enable / disable simultaneous zooming of the thermal camera and the zoom camera.

**Main / Sub Stream:** Configure the main stream and the sub stream separately for their camera source and parameters.

**Image Mode:** Select the video stream's image type and camera source. Single image or split image. Zoom camera, wide angle camera, or thermal imaging camera.

**Stream Resolution:** Decide to switch the output resolution of the current video stream or not according to camera source. Max output resolution is Ultra HD (1080p).

**Record Resolution:** Decide to switch the recording resolution or not according to camera source. Max record resolution is 4K.

**Gimbal Working Mode:** Switch gimbal working mode among Lock Mode, Follow Mode, and FPV Mode.

- Lock Mode: Horizontally, gimbal does not follow when aircraft rotates.
- Follow Mode: Horizontally, gimbal follows when aircraft rotates.
- FPV Mode: Gimbal rotates simultaneously as aircraft rolls to get FPV view, and output images with enhanced stability.

**Camera Firmware Version:** Display current camera firmware version.

**Gimbal Firmware Version:** Display current gimbal firmware version.

**Zoom Firmware Version:** Display current gimbal firmware version.

## 5.4 About SIYI FPV

Displays the software version of SIYI FPV and common contact information of SIYI Technology.



## 5.5 SIYI FPV App Update Log

<b>Date</b>	2023-08-24
<b>Version</b>	2.5.15.660
<b>Updates</b>	<ul style="list-style-type: none"> <li>4. New (ZT30): Laser calibration. Display laser ranging target's coordinates.</li> <li>5. New: Support TF format.</li> <li>6. New (ZT30): Thermal color palette.</li> <li>7. New: File manager to preview stored pictures in TF card.</li> <li>8. Improve: New icon indication for missing TF card.</li> </ul>

<b>Date</b>	2023-07-31
<b>Version</b>	2.5.14.644
<b>Updates</b>	<ul style="list-style-type: none"> <li>1. New: Status indication for successfully integrated flight controller attitude data.</li> <li>2. New: Google map is supported.</li> <li>3. Fix: Flight controller location was no accurate. New icons for flight controller location and device location.</li> <li>4. New: Status indication for missing TF card.</li> </ul>

## 6 IMAGE TRANSMISSION

The MK15 link supports up to 1080p resolution, 60 fps, and real-time image transmission with a latency as low as 150 milliseconds. It is suitable for SIYI optical pods and gimbal cameras and supports connecting to third-party optical pods and gimbal cameras. The external air unit HDMI input converter can be expanded to support cameras with HDMI input. The external multi-camera adapter module (FPV Hub) can expand the connection to support multiple video stream inputs.

### 6.1 Control Gimbal Camera from SIYI FPV App or SIYI QGC App on SIYI Handheld Ground Station

Gimbal connects to air unit directly to control gimbal rotation, gimbal functions, and video display in SIYI FPV app or SIYI QGC app when the air unit is communicating with the ground station.

#### 6.1.1 Preparation

It is necessary to prepare the tools, firmware, and software below before controlling gimbal camera in this way.

- SIYI Handheld Ground Station (MK32 Standard Combo / MK15 Enterprise Standard Combo is suggested for excellent compatibility with SIYI gimbal cameras)



- A8 mini Gimbal Camera

### **Mark**

Above products can be purchased from SIYI directly or from SIYI authorized dealers.

- SIYI Gimbal to SIYI Link Cable

### **Mark**

Above tools come with product package.

- SIYI FPV App (v2.5.15.660 or latest version)
- SIYI QGC App

### **Mark**

Above software can be downloaded from relevant product page on SIYI official website.

## **SIYI FPV App Steps**

1. Power air unit and bind it with ground station.
2. Use SIYI Gimbal to SIYI Link Cable to connect the air unit's Ethernet port with the gimbal camera's Ethernet port.
3. Update SIYI FPV app to the latest.
4. Run SIYI FPV app, go to "Settings" and select the relevant SIYI camera type with

main / sub stream, video stream will display. Gimbal motion and camera functions can be controlled by ground station touchscreen.

## SIYI QGC App Steps

1. Power air unit and bind it with ground station.
2. Use SIYI Gimbal to SIYI Link Cable to connect the air unit's Ethernet port with the gimbal camera's Ethernet port.
3. Run SIYI QGC app, go to "Comm Links – Video Settings", and select "RTSP Video Stream" for "Source", then enter the default RTSP addresses of SIYI gimbal camera, video stream will display. Gimbal motion and camera functions can be controlled by ground station touchscreen.

### 6.1.2 Gimbal Pitch and Yaw Rotation

While SIYI FPV App or SIYI QGC app is running,

Sliding on touchscreen can control gimbal rotation. Sliding left and right are yaw rotation, up and down are gimbal pitch rotation.

Double tap touchscreen, gimbal will automatically center.

#### **Mark**

Slide on touchscreen and hold it, gimbal will continue rotating till it reaches physical limit.

Farther that you hold it from the center of the screen, faster the gimbal rotates.

### 6.1.3 Zoom

While SIYI FPV App or SIYI QGC app is running,

Touching “Zoom in” or “Zoom out” icon on can control the zoom camera, up to 6X digital zoom.

### 6.1.4 Take pictures and Record Video

While SIYI FPV App or SIYI QGC app is running,

Touch “Photo” icon once on to take a picture. Touch “Record” icon to start video recording. Touch “Recording” icon to stop video recording.

### Mark

Before taking a picture or recording video, it is necessary to insert SD card into the camera.

## 6.2 Input Third-Party IP Cameras / Optical Pods

Before connecting a third-party camera to the air unit, please change its IP address to “192.168.144.X”. The X should not be “11”, “12”, or “20”, otherwise it won't work.

The three addresses have been occupied by the air unit, the ground unit, and the Android system.

### Steps

1. In camera settings, check and copy the RTSP address of your camera.
2. Let's take SIYI QGroundControl as an example. Run QGC, go to "General – Video Settings".

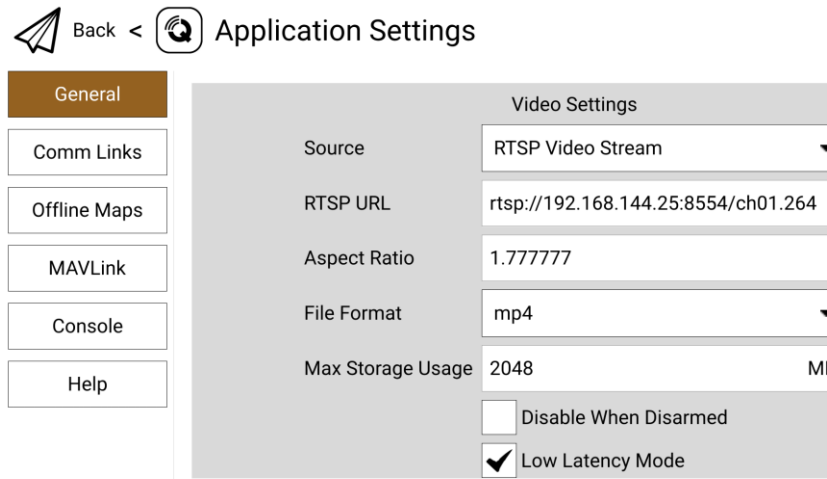

3. Configure "Source" as "RTSP Video Stream". Then input the copied RTSP address of your camera after "RTSP URL".
4. Go back to QGC home page to check image display.

### 6.3 Input HDMI Camera

HDMI camera must be through the SIYI air unit HDMI input converter to output to the SIYI air unit, please refer to the steps below for detail.

1. Let's take SIYI QGroundControl as an example. Run QGC, go to "General - Video Settings".
2. Configure "Source" as "RTSP Video Stream". Then input the RTSP addresses of the SIYI HDMI converter for "RTSP URL".
3. Go back to QGC home page to check image display.

## 6.4 Input Dual-Channel Video Streams

Input dual-channel video stream to the air unit must be through the FPV Hub. Dual-channel video stream can work in multiple ways.

### Mark

Dual video stream does not work when the two cameras use the same IP address.

For more details about the IP addresses of SIYI links and gimbal cameras, please refer to the chapter 6.5 in this manual.

### 6.4.1 Input Dual SIYI Cameras / Gimbals / Air Unit HDMI Input Converters

Please assign different IP addresses to SIYI cameras, gimbals, and air unit input converters. It is suggested to use “192.168.144.25” and “192.168.144.26”. Then, after connecting both cameras / converters to the FPV Hub and running SIYI FPV app, you can see dual video stream when the IP addresses are selected as “SIYI Camera 1” and “SIYI Camera 2”.

### 6.4.2 Input Dual Third-Party IP Cameras / Optical Pods

Make sure that the two IP cameras / pods use different IP addresses and connect them to the FPV Hub. Then open SIYI FPV app, input the RTSP addresses, and you will see two video streams.

### **6.4.3 Input an SIYI HDMI Converter and a Third-Party IP Camera**

Make sure that the IP camera use a different IP address from the HDMI converter and connect them to the FPV Hub. Then open SIYI FPV app, input the RTSP addresses, and you will see two video streams.

## 6.5 Common IP Addresses

Air Unit IP Address: 192.168.144.11

Remote Controller IP Address: 192.168.144.12

Android System IP Address: 192.168.144.20

SIYI Camera / Gimbal IP Address: 192.168.144.25

IP67 Camera A's IP Address: 192.168.144.25

IP67 Camera B's IP Address: 192.168.144.26

Air Unit HDMI Input Converter's IP Address: 192.168.144.25

IP67 Camera A's RTSP Address: rtsp://192.168.144.25:8554/main.264

IP67 Camera B's RTSP Address: rtsp://192.168.144.26:8554/main.264

Air Unit HDMI Input Converter's RTSP Address: rtsp://192.168.144.25:8554/main.264

Common Video Player: SIYI FPV, QGroundControl, EasyPlayer

Network Diagnosis Tool: Ping Tools

### **Mark**

SIYI FPV camera and air unit HDMI input converter are labeled with RTSP addresses before delivery. Please pay an attention.

## 6.6 Solutions to No Image

If MK15 remote controller failed to display image, please try to follow the steps below to investigate possible reasons.

### 1. Check communication:

- If the remote controller is bound with the air unit (remote controller and air unit status indicator is green)?
- If the camera is well connected to the air unit (remote controller successfully pings to the air unit and to the camera IP addresses)?

### 2. Check software settings:

- SIYI FPV App: If camera IP addresses are correct?
- QGroundControl App: If RTSP addresses are correct?

### 3. Check network:

Ethernet Switch: In Android system status bar, check if the Ethernet icon exists.

If not, please enable Ethernet function in Android system settings.

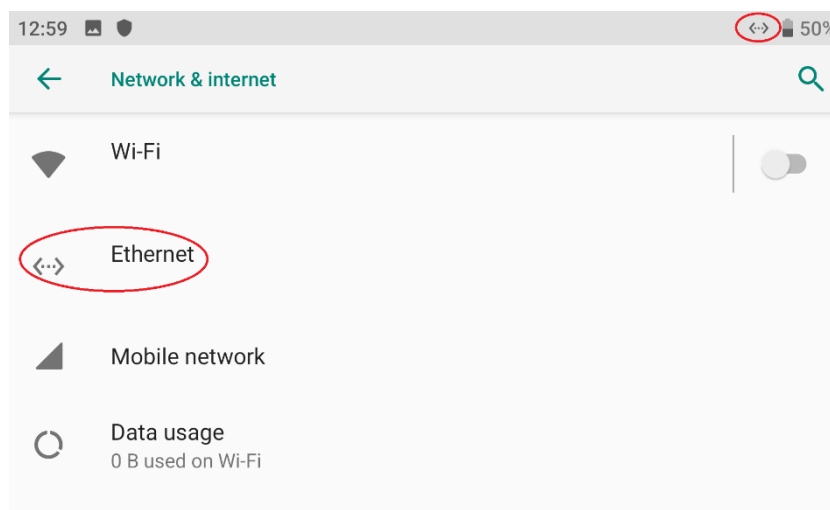



If you have done trouble shooting by following all steps above, but there are still no clues, please contact your reseller or SIYI after-sale service.

## 6.7 Output Video Stream from Remote Controller

There are multiple ways to output video stream from remote controller.

### 6.7.1 Through HDMI

It's just one step outputting video stream to an HDMI monitor.

Use a standard HDMI cable to connect remote controller's HDMI port to the monitor's HDMI port, the video stream will display.

### 6.7.2 Through WiFi Hotspot

Let's take an example of outputting video stream to a Windows laptop, running SIYI QGroundControl.

1. Go to Android system settings "Network & Internet – Hotspot & Tethering – Wi-Fi Hotspot".

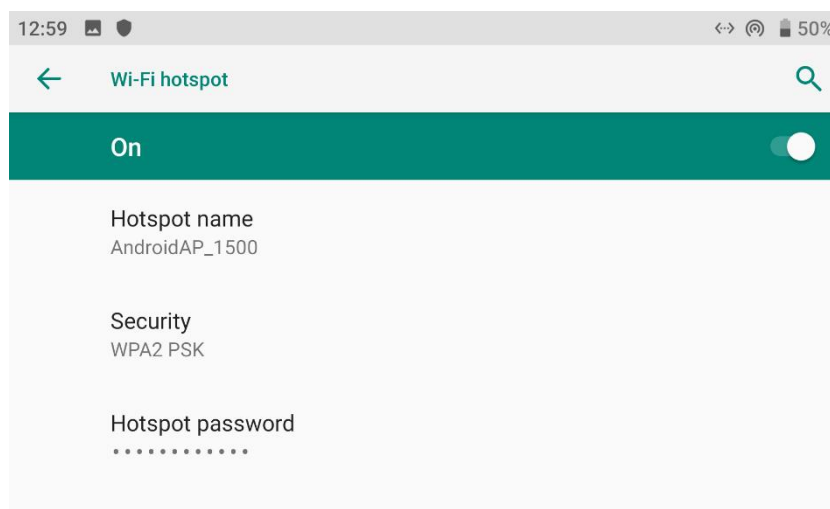

2. Enable "Wi-Fi Hotspot", configure the hotspot name and its password.

3. Connect the Windows laptop's with the remote controller through WiFi.
4. Run SIYI QGroundControl on the laptop, go to "Application Settings - Video".

Switch the video source to "RTSP Video Stream".

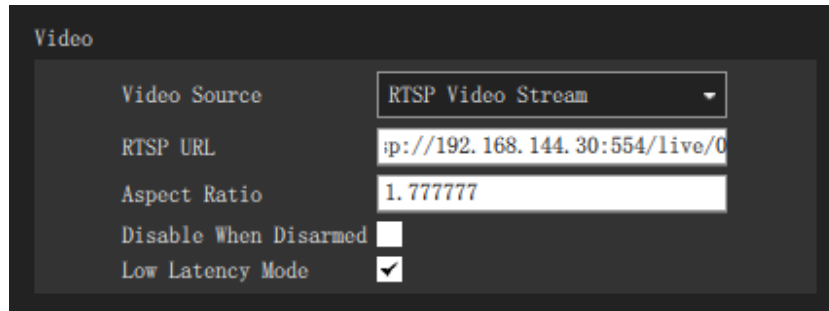

5. In "RTSP URL", input the RTSP addresses of the camera, return to QGC homepage and you will see the video stream.

### Mark

If the same video source is used in the laptop and the remote controller simultaneously, one of the video streams may delay or stuck due to bandwidth limit. If it happens, you can assign one video stream as "SIYI Camera 1 / 2" protocol, and another video stream as standard RTSP protocol.

## 7 ANDROID OS

### 7.1 Download Apps

Pre-installed applications in the remote controller are:

- SIYI TX
- SIYI FPV
- SIYI QGroundControl
- Ping Tools

If you need to download the above apps, please visit the relevant product pages on SIYI Official Sites ([www.siyi.biz](http://www.siyi.biz)).

### 7.2 Import and Install App

#### 7.2.1 Through TF Card

Save the files into your TF card and insert the card into the remote controller. Copy the files from the TF card to the Android system storage. Then go to “File Manger” in the Android system and find the files to install.

#### 7.2.2 Through USB Disk

Save the files into your USB disk and plug the disk onto the remote controller. Copy

the files from the disk to the Android system storage. Then go to “File Manger” in the Android system and find the files to install.

 **CAUTION**

Please try to simplify the Android system as much as possible and avoid installing useless apps to avoid possible system overwhelming during flight.

### 7.2.3 Through Type-C File Transfer

Remote controller can be connected to Windows computer directly through the Type-C port as file transfer mode.

#### Steps

1. Connect the remote controller to the Windows computer through the Type-C port.
2. Confirm to “Disable video stream to enable Type-C data transfer”.

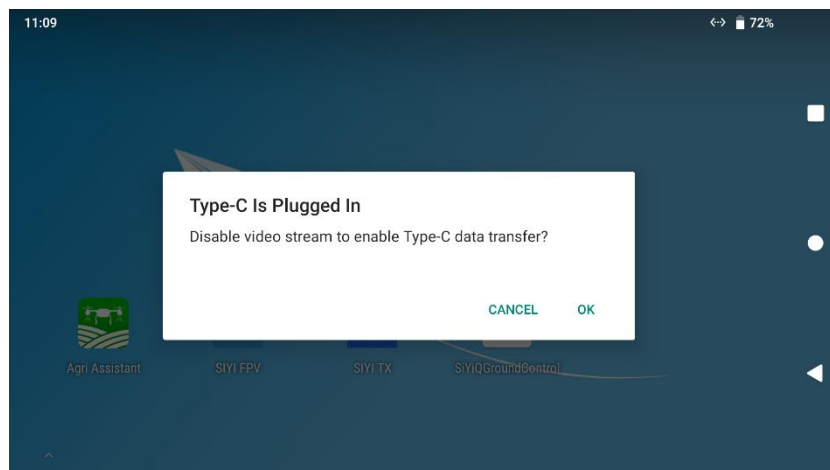

3. Tap “Android System – Charging this device via USB”.

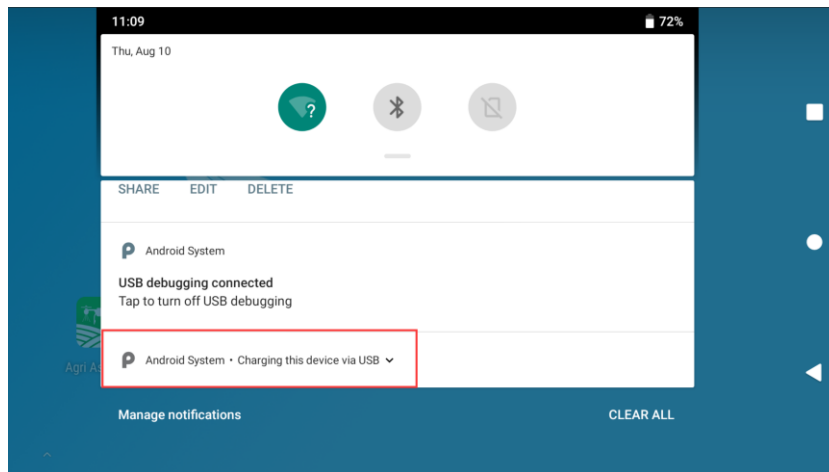

4. Keep tap for more information.

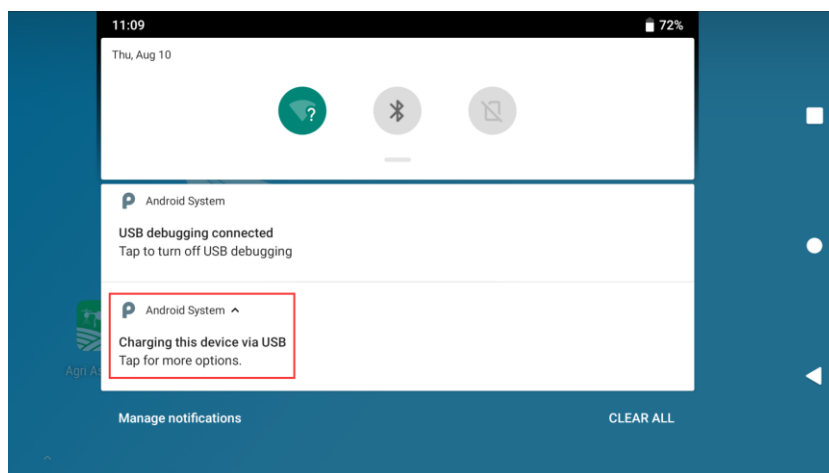

5. Choose "File Transfer".

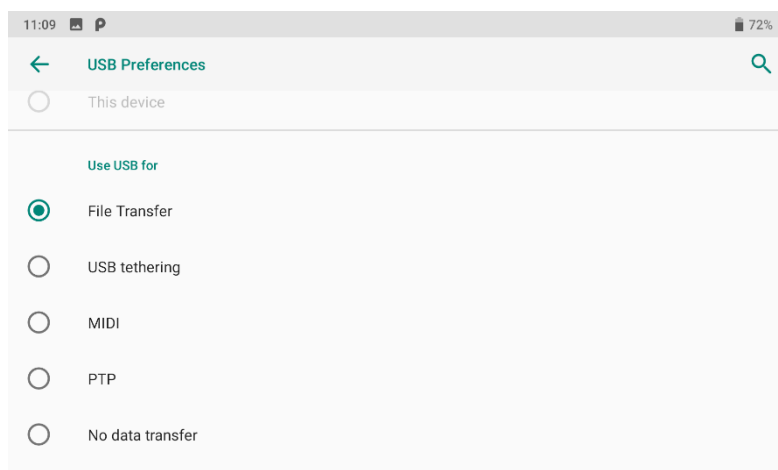

6. You will see the remote controller as a storage device in your Windows computer.



## 7.3 Check Android Firmware Version

Remote controller carries a specialized Android system.

### Steps

1. Go to Android system settings.

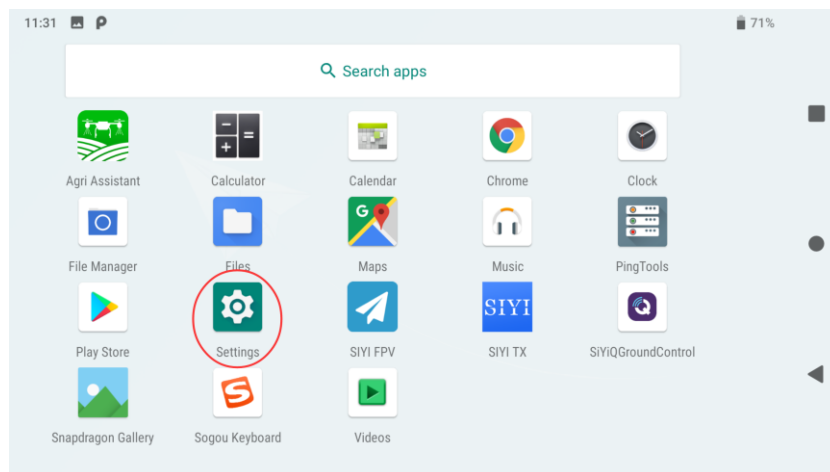

2. Slide down to the “About Phone” settings.

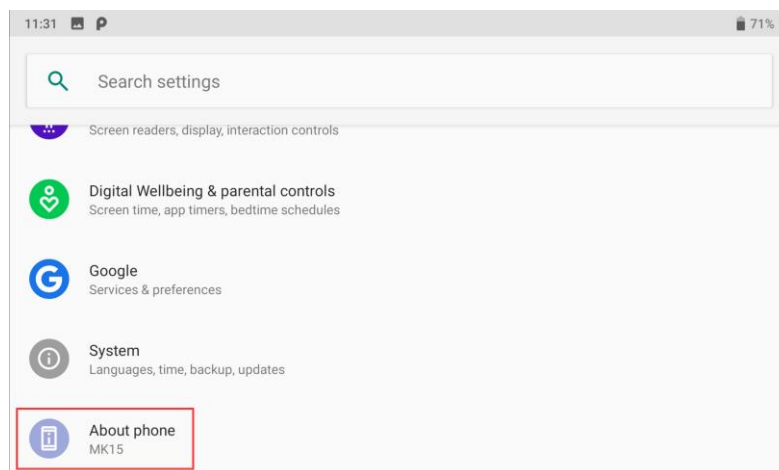

3. Slide down to the last option to check the Android firmware version.



## 8 SIYI Assistant

SIYI PC Assistant is a Windows software developed by SIYI to configure many SIYI products for configuration, firmware update, and calibration.

### **Mark**

The manual is edited based on SIYI PC Assistant v1.3.7.

SIYI PC Assistant and the relevant firmware pack can be downloaded from SIYI official website:

<https://siyi.biz/en/index.php?id=downloads1&asd=193>

## 8.1 Firmware Update

SIYI remote controller and air unit can be connected to Windows computer and be upgraded through SIYI Assistant.

Before upgrading, it is necessary to prepare the tools, software, and firmware below.

- SIYI PC Assistant (v1.3.7 or latest version)
- Remote Controller Firmware
- Air Unit Firmware

### **Mark**

Above software and firmware can be downloaded from relevant product page on SIYI official website.

- Cable (USB-C to USB-A)

### **Mark**

Above tools come with product package.

## Firmware Upgrade Steps

1. Install “SIYI Assistant” on your Windows device.
2. Use the upgrade cable to connect the remote controller’s upgrade port to the Windows computer’s USB port.
3. Run “SIYI Assistant” and switch to the “Upload” page to check the current firmware version of the remote controller and the air unit.

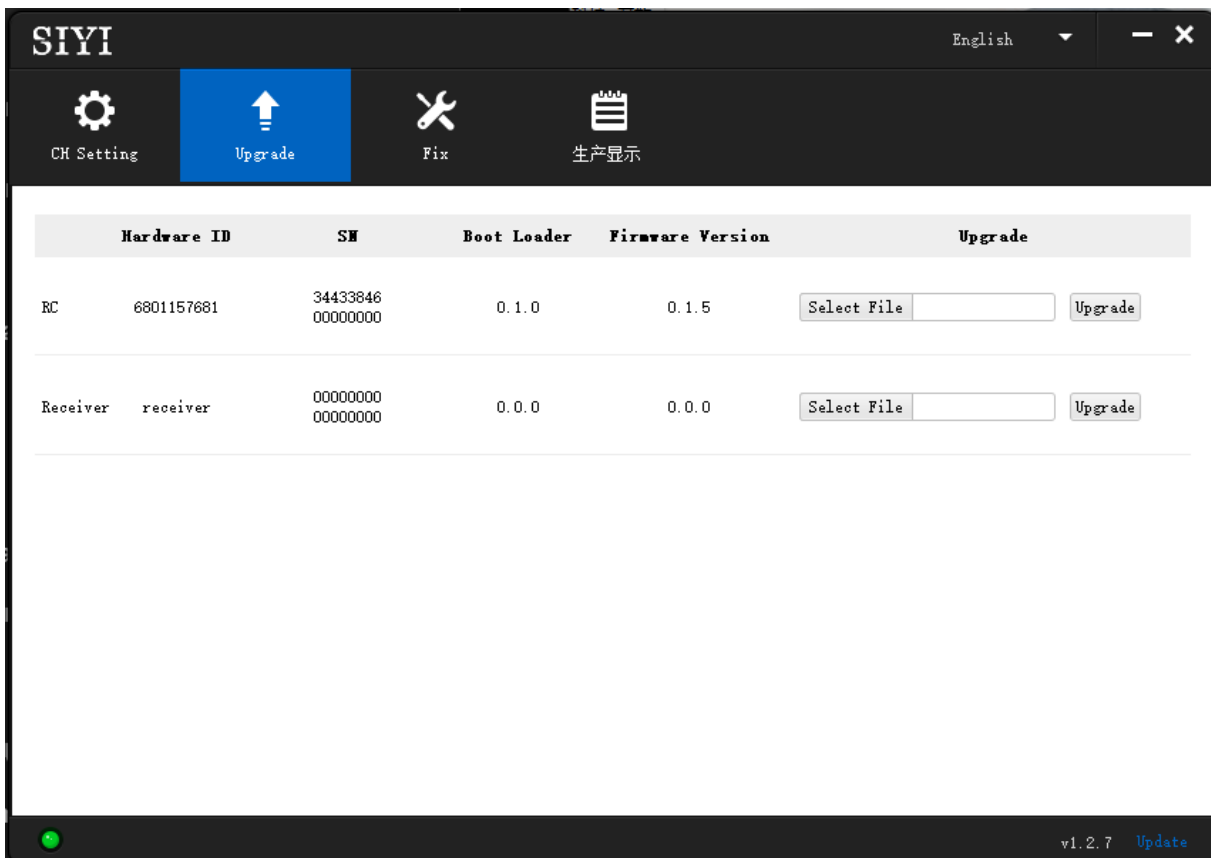

4. If the firmware is not the latest, then click the “Select File” button in the “RC” line to import the latest remote controller firmware. Then click “Upgrade” and wait till it is “100%” finished.

5. Disconnect the ground unit from the Windows device. Connect the air unit's Type-C port to your Windows device's USB port. Then repeat the above steps to upgrade air unit firmware.

**Mark**

Please choose the correct firmware according to the initial number in the boot loader number version. For instance, if the boot loader number is 5.1.0, then please choose the firmware version starting with number 5. If the boot loader number is 0.1.0, then please choose the RF firmware version with number 0.

Hardware ID	SN	Boot Loader	Firmware Version	Upgrade
RC 6801157681	34433846 00000000	0.1.0	0.1.5	Select File <input type="text"/> Upgrade
Receiver receiver	00000000 00000000	0.0.0	0.0.0	Select File <input type="text"/> Upgrade

Don't worry if the ground unit firmware and the air unit firmware are different in initial numbers, they can still bind and work normally if their firmware version match.

## 8.2 Main Firmware Update Log

<b>Date</b>	2023-04-03
<b>Remote Controller Firmware</b>	V5.4.2 svn6565
<b>Air Unit Firmware</b>	V5.2.8 svn6270
<b>Updates</b>	<ol style="list-style-type: none"> <li>1. New: Now SIYI datalink SDK can request remote controller and air unit firmware version.</li> <li>2. New: Now the 4-pin serial port on the top of the remote controller is recognizable.</li> <li>3. New: Compatible with a new Bluetooth chip.</li> <li>4. New: Compatible with A2 mini gimbal pitch rotation control.</li> <li>5. New: Support binding to up to five air units in turns.</li> </ol>

### 8.3 SIYI Assistant Update Log

<b>Date</b>	2023-08-24
<b>Version</b>	v1.3.7 svn6958
<b>Updates</b>	<ol style="list-style-type: none"> <li>1. New: Compatibility to a new model.</li> <li>2. New: Support ZT30 to switch between H265 and H264 codec.</li> <li>3. Improve: Gimbal calibration function has its own page now.</li> <li>4. New: Gimbal configuration (thermal synchronize zoom, thermal color palette)</li> </ol>

## 9 After-sale Service

If there were any questions or problems using SIYI Technology's product, you can always try to send an email to SIYI Official A/S Center ([support@siyi.biz](mailto:support@siyi.biz)) or consult your sales representative or dealer for answers or solutions.

### 9.1 Repair Service

If your purchased SIYI products cannot work properly, please contact SIYI Official A/S Center for consulting.

Usually there are two situations for acquiring repair service.

- Product Defect
- Product Damage

SIYI products under the two situations can be sent back to SIYI for repairing. Defect products with valid warranty can be repaired for free. Defect products without valid warranty or damaged products should be charged of repair fees after repairing. Please refer to SIYI's Official A/S Quotation for detail.

## 9.2 Warranty

SIYI Technology guarantees that, subject to the following conditions, Return & Refund Service, Replacement Service, and Warranty Repair Service can be requested. Please contact SIYI directly ([support@siyi.biz](mailto:support@siyi.biz) or your sales manager) or authorized SIYI dealer for more detail.

### 9.2.1 7-Day Return & Refund

You can request Return & Refund Service:

Within seven (7) days of receiving a product if the product has no manufacturing defect, has not been activated and is still in new or like-new condition.

Within seven (7) days of receiving a product if the product has a manufacturing defect.

Return & Refund Service will not be provided where:

It is requested beyond seven (7) calendar days of receiving a product.

A product sent to SIYI for Return & Refund Service does not include all original accessories, attachments or packaging, or any item is not in new or like-new condition, i.e., with cracks, dents, or scratches.

A legal proof of purchase, receipt or invoice is not provided or is reasonably believed to have been forged or tampered with.



Any fault or damage of the product is caused by unauthorized use or modification of the product, including exposure to moisture, entry of foreign bodies (water, oil, sand, etc.) or improper installation or operation.

Product labels, serial numbers, waterproof marks, etc. show signs of tampering or alteration.

Damage is caused to the product by uncontrollable external factors, including fire, floods, high winds, or lightning strikes.

A product is not delivered to SIYI within seven (7) calendar days after Return & Refund Service confirmation is sent from SIYI.

Other circumstances stated in this policy.

### **9.2.2 15-Day Replacement**

You can request Replacement Service:

Within fifteen (15) calendar days of receiving the product if the product has sustained a substantial damage in transit, provided always that the damage proof issued by the carrier can be provided to SIYI.

Within fifteen (15) calendar days of receiving the product if the product does not match the original description of the product in one or more significant respects.

Within fifteen (15) calendar days of receiving the product if the product suffers performance failure.

Replacement Service will not be provided where:

Service is requested more than fifteen (15) calendars days after receiving a product.

Legal proof-of-purchase, receipts, or invoices are not provided, or are reasonably believed to have been forged or tampered with.

A product sent to SIYI for replacement does not include all original accessories, attachments, and packaging, or contains items damaged by user error.

A product is found to have no defects after all appropriate tests are conducted by SIYI.

Any fault or damage of the product is caused by unauthorized use or modification of the product, including exposure to moisture, entry of foreign bodies (water, oil, sand, etc.) or improper installation or operation.

Damage is caused by uncontrollable external factors, including fires, floods, high winds, or lightning strikes.

Received product has not been sent back to SIYI seven (7) calendar days after replacement confirmation from SIYI.

Proof of damage during transit issued by the carrier cannot be provided.

Other circumstances stated in this policy.

### 9.2.3 1-Year Warranty Repair

You can request warranty repair service:

If a product does not function as warranted during the warranty period, you may obtain after-sales service by contacting SIYI's service center. You will need to provide a valid proof-of-purchase, receipt, or order number for the warranty service.

Charges may apply for services not covered by this Limited Warranty. Please contact SIYI for information specific to your location.

Please note that the warranty service is only available in the respective SIYI service regions where you purchased your SIYI product.

Warranty Repair service will not be provided where:

Crashes or fire damage caused by non-manufacturing factors, including but not limited to pilot errors.

Damage caused by unauthorized modification, disassembly, or shell opening not in accordance with official instructions or manuals.

Damage caused by improper installation, in correct use, or operation not in accordance with official instructions or manuals.

Damage caused by non-authorized service provider.

Damage caused by unauthorized modification of circuits and mismatch or misuse of the battery and charger.

Damage caused by operation in bad weather (i.e., strong winds, rain, sand/dust storms, etc.)

Damage caused by operating the product in an environment with electromagnetic interference (i.e., in mining areas or close to radio transmission towers, high-voltage wires, substations, etc.)

Damage caused by operating the product in an environment suffering from interference from other wireless devices (i.e., transmitter, video-downlink, Wi-Fi signals, etc.)

Damage caused by reliability or compatibility issues when using unauthorized third-party parts.

Damage caused by operating the unit with a low-charged or defective battery.

Products or parts with an altered identification label or from which the identification label has been removed.

## 10 FCC STATEMENT

This device complies with Part 15 of the FCC Rules. Operation is subject to the following two conditions:

- (1) This device may not cause harmful interference, and
- (2) This device must accept any interference received, including interference that may cause undesired operation.



### **WARNING**

Changes or modifications not expressly approved by the party responsible for compliance could void the user's authority to operate the equipment.

NOTE: This equipment has been tested and found to comply with the limits for a Class B digital device, pursuant to Part 15 of the FCC Rules. These limits are designed to provide reasonable protection against harmful interference in a residential installation. This equipment generates uses and can radiate radio frequency energy and, if not installed and used in accordance with the instructions, may cause harmful interference to radio communications. However, there is no guarantee that interference will not occur in a particular installation. If this equipment does cause harmful interference to radio or television reception, which can be determined by turning the equipment off and on, the user is encouraged to try to correct the interference by one or more of the following measures:

Reorient or relocate the receiving antenna.

Increase the separation between the equipment and Air Unit. Connect the equipment into an outlet on a circuit different from that to which the Air Unit is connected.

Consult the dealer or an experienced radio/TV technician for help.

**RF Radiation Exposure Statement:**

This equipment complies with FCC radiation exposure limits set forth for an uncontrolled environment. This equipment should be installed and operated with minimum distance 20cm between the radiator & your body.

**SIYI Technology**

Business Inquiry: [info@siyi.biz](mailto:info@siyi.biz)

Phone: +86 400 838 2918

A/S Center: [support@siyi.biz](mailto:support@siyi.biz)